



THUASNE

2017
Product Catalog



 **TOWNSEND**
THUASNE USA

 **QUINN MEDICAL**
THUASNE USA



Table of Contents

Get To Know Us..... 3

About Thuasne USA.....	3
Thuasne Technology.....	4
Townsend Technology.....	6
Quinn Medical Technology.....	8
Central Fabrication.....	10
Options for Joints and Colors.....	11

Foot & Ankle.....12

Ankle.....	13
Walking Boots / Night Splints.....	16
Ankle Foot Orthoses.....	20

Knee.....24

Knee Support.....	25
Knee Post Op.....	28
Knee Ligament.....	30
Knee Osteoarthritis.....	36
Knee Locking / Hyperextension / BK.....	44
Knee Ankle Foot Orthoses.....	48

Lower Spine.....50

Lower Spine / Maternity.....	54
Upper Spine / Cervical.....	55

Upper Extremity58

Shoulder/Elbow.....	60
Wrist/Thumb.....	62

Pediatric 64

Knee.....	65
Foot.....	66
Clavicular.....	66
Cervical.....	67
Wrist.....	67

Ordering and Warranty 68

Casting, Scanning and CCS Options.....70

Returns, Exchanges and Credits..... 74



Thuasne USA

We now have three well-known, highly respected orthopedic manufacturers under one umbrella - Thuasne USA. The highest quality workmanship, technology and experience – coming together to meet your orthopedic needs.

Thuasne

Founded in France in 1847, The Thuasne Group is one of Europe's oldest, largest and most respected orthopedic companies, specializing in wearable medical devices. Thuasne has over 1,800 employees and subsidiary companies throughout Europe.

Townsend

Founded in 1984, Townsend Design is one of the orthopedic industry's most respected manufacturers of ligament and OA knee braces, specialty lower extremity orthoses, and rehabilitation mobility devices.

Acquired by Thuasne in 2011, Townsend has over 175 employees. Townsend's manufacturing and distribution center is in Bakersfield, California.

Quinn Medical

Founded in 2011, Quinn Medical disrupted the orthopedic industry by releasing their innovative universal sized spine brace (The Sleep).

Quinn's innovative patented technology and comfortable brace designs rapidly gained market share and the company was acquired by Thuasne in 2016. Quinn's office and distribution center is in San Clemente, California.



THE DUCOTTET FAMILY

Anne-Sophie Ducottet, Delphine (Ducottet) Henton, Elizabeth Ducottet, and Mathieu Ducottet



The Thuasne angel logo is symbolic of the company's heritage and its desire to provide "wings for your health" by elevating each person's active involvement in their own well being and medical care.

Thuasne Technology: Our working principles



Spinning and Covering

SPINNING: Fibers are converted into yarn

COVERING: Elastic and non-elastic yarns are combined. This process allows Thuasne to precisely define the elasticity of the yarn to achieve international compression standards.

FIBER
mainly synthetic fibers such as polyamide, elastane, polyester

YARN

FABRIC

How are Thuasne knitted braces manufactured?

Knitting

KNITTING: Series of interlocking loops made with different types of yarn. This structure is designed with a precise map in order to adapt to the anatomy.

Thuasne knitted braces offer a number of advantages when compared to neoprene-type braces

	THUASNE KNITTED BRACE	NEOPRENE BRACE
EFFICACY		
Compression.	International standards guarantee compression levels.	No standard to measure compression.
Proprioception Promotes natural stabilization, reduces pain and swelling.	Exclusive knitting process ensures the brace fits the anatomical contours of the body. This provides even compression throughout the entire area.	Neoprene is uniform in structure and composition. When the material is sewn together, it creates a tube and does not fit anatomically.
COMFORT		
Breathability.	The knitted materials have large, evenly spaced pores to ensure a high level of air permeability.	Not conducive to airflow, retains heat.
Comfortable for daily use.	Standard fibers (polyamide) are hypoallergenic and gentle on the skin.	Retains heat, sweat cannot evaporate which causes discomfort on the skin and increased risk of skin irritation.
Overall fit.	Our fabric remains flexible and adapts itself to the wearer's body all day long to avoid tourniquet effect and migration.	Neoprene has a tubular design which does not fit nor adapt to the body. In addition, it tends to migrate and roll.

Thuasne's effective and comfortable knitted braces have a significant effect on therapeutic results and overall patient compliance.

What are the benefits of Thuasne's exclusive process of manufacturing knitted braces ?

Efficacy

THUASNE knitted braces have medically proven compression to:

- Restore the proprioceptive message (perception of the body) that enables natural stabilization. The skin is stimulated and nervous system activated when using knitted braces.
- Promote blood circulation to reduce pain and swelling.

Safety

THUASNE knitted braces are breathable, hypoallergenic and latex free. The elastic and anatomical fabric avoids constricting circulation and tourniquet effect.

Comfort

In knitted fabric, air can easily flow through. THUASNE knitted braces are naturally breathable.

BENEFITS:

- Natural cooling effect
- Avoids heat build up on the skin
- Allows sweat to evaporate
- Allows long lasting use

THUASNE knitted braces have specific anatomical structure to adapt to each patient's morphology during daily activities (i.e. specific areas for malleoli, knee, popliteal fossa, elbow crease).

BENEFITS:

- Avoids constricting circulation
- Prevents migration
- Eliminates bunching and pinching

Thuasne standard fibers for knitting are soft, light, breathable, durable and comfortable.

Examples of knitted areas on Thuasne braces

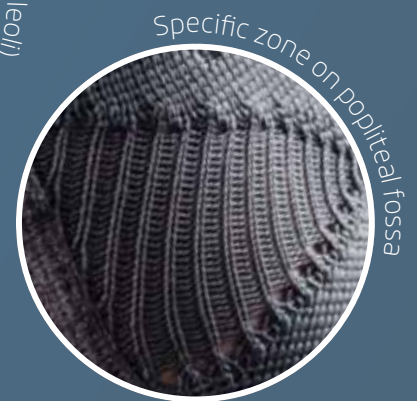
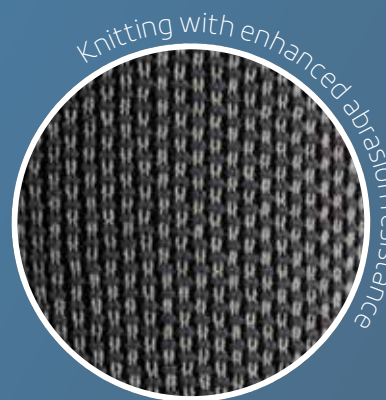
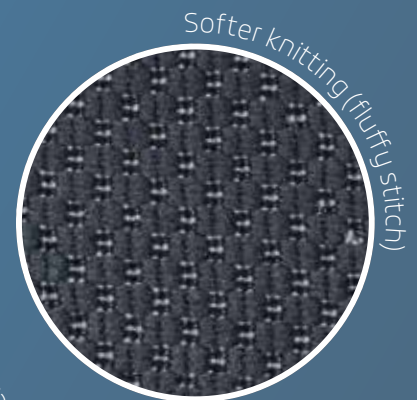
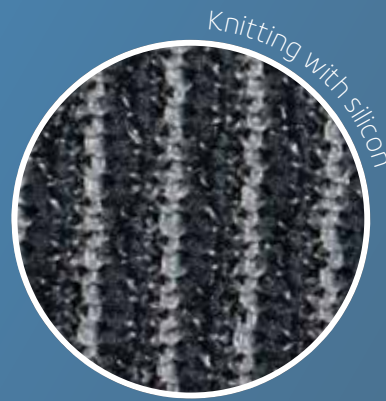

Townsend Technology

Hinge Motion Matters



The Townsend Motion Hinge tracks with the anatomical roll-and-glide motion of the knee. The hinges keep the brace properly positioned on the limb throughout range of motion. This optimizes the function and suspension of the brace, producing the best outcomes and highest levels of patient compliance. This is in contrast to knee braces with generic polycentric hinges (used by other companies) that conflict with normal knee motion – causing the brace to gap, piston and migrate.

Townsend Motion Hinge

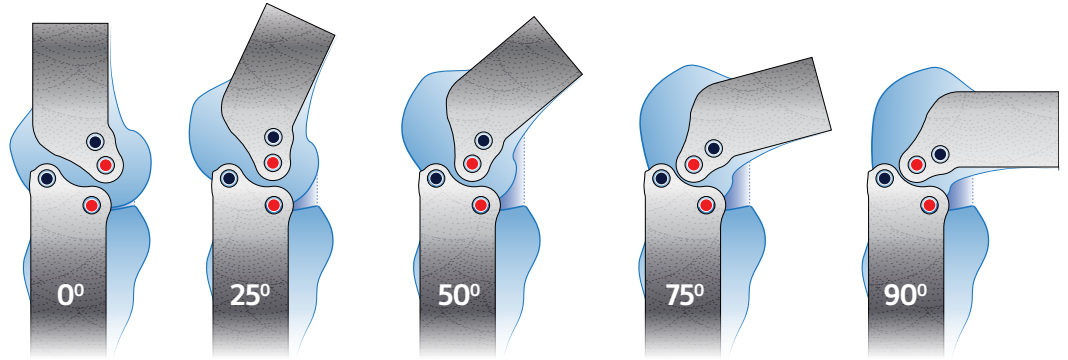

Geared Polycentric Hinge

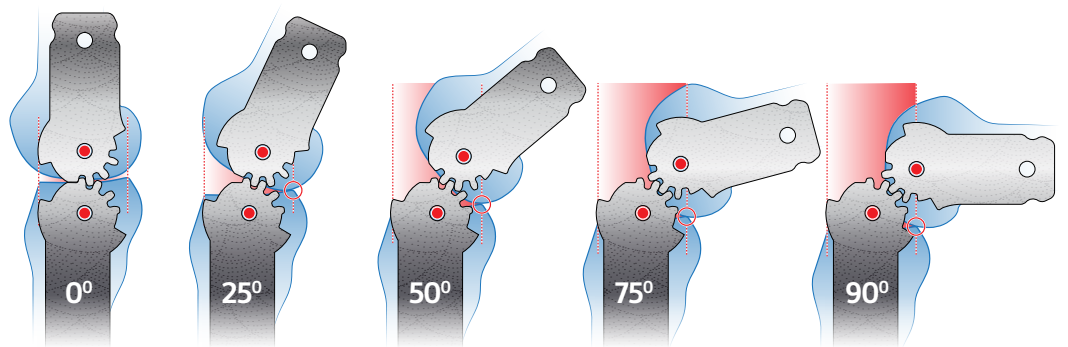

Adjustable Correction For OA Braces

The patented LoadShifter mechanism and tool-less SnapLock are innovative features incorporated into the femoral section of Townsend's most popular rigid OA knee braces.

By releasing the SnapLock, the fitter can utilize the LoadShifter to adjust the angle of the thigh shell.

Increasing corrective pressure at the top of the leg amplifies the three-point counterforce at the knee and distal end of the brace – improving leg alignment and reducing compressive load on the damaged side of the knee.

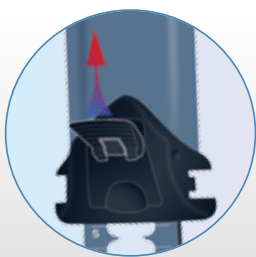

Lift

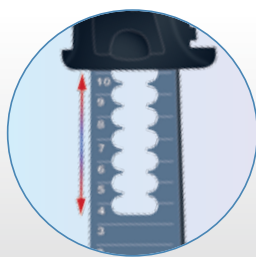

Slide

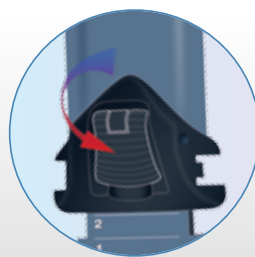

Lock



Anti - Migration

C/S Package

Keeping the brace ideally positioned on the leg, and preventing brace slippage, are hallmarks of Townsend's technology. As a 'no migration' insurance policy, Townsend offers its patented Compression/Suspension Package. This pairing of semi-rigid padded sub-shells, strategically mounted into opposing sides of the thigh section of the brace, is a simple yet revolutionary innovation. When the straps are tensioned, the pads compress into the femoral tissue above the bony condyles, comfortably burrowing into soft tissue to eliminate any potential for brace migration.



Synergistic Suspension

Our proprietary Synergistic Suspension Strap works brilliantly with the hinges and structural design of Townsend's knee braces. The position and attachment is innovative. It nestles into the flexion fold behind the knee, tightening into the medial and lateral sides of the leg. It utilizes the top of the calf muscle as an anatomical shelf, and because the strap is non-elastic, it can't slip down over the wider aspect of the calf.

Rotation Control

Comfortable Support

Townsend is the only manufacturer that specifically addresses the issue of brace rotation. For ligament instabilities and OA, controlling internal or external rotation is critical to the function of the brace. Townsend has invented a variety of solutions to prevent brace rotation by use of tibial shell bolsters and contours.

The tibia band on every Premier and Rebel Series brace is contoured to fit intimately along the flatter medial side and rounded lateral side.

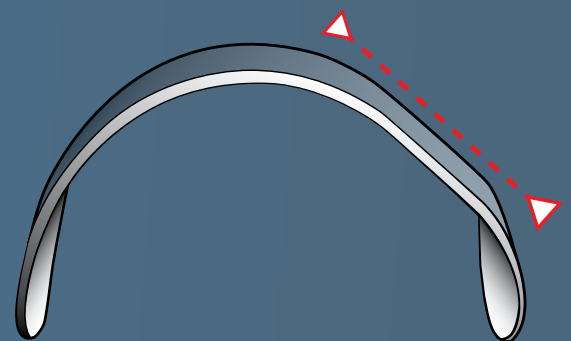



QUINN MEDICAL
THUASNE USA

(((SLEEQ))) spinal therapy system with InvisAdjust™

The SLEEQ revolutionized back bracing with its ingeniously simple ability to fit nearly any waist size and body type. While universal sized braces are now an industry standard, the patented SLEEQ technology offers unmatched ease of adjustment and adaptability for optimum fit, function and comfort.

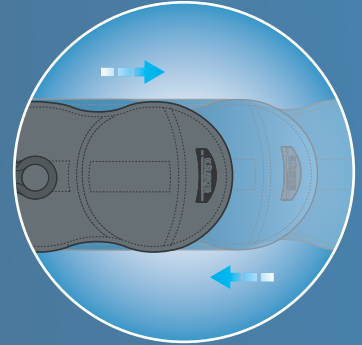

Universal Sizing

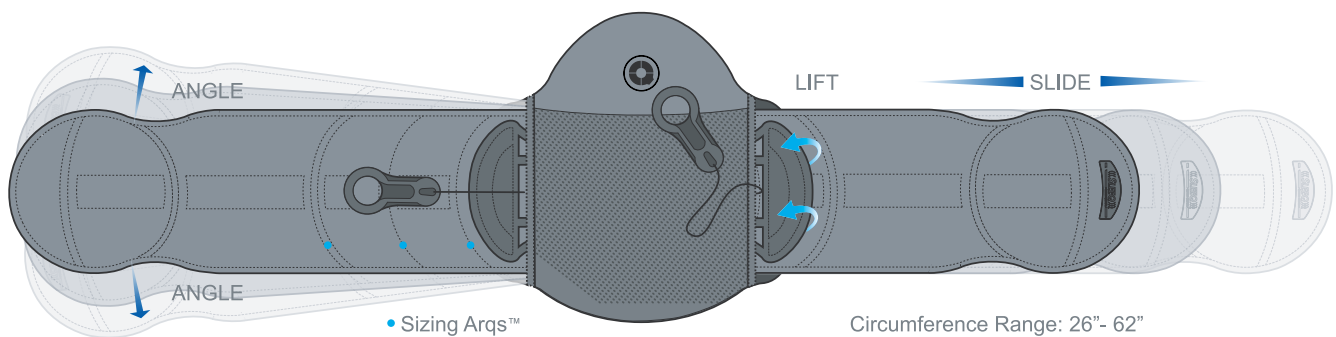

Every SLEEQ™ model adjusts to fit the vast majority of patients. Sizing Arqs™ provide landmarks for waist circumference and proper alignment, enabling nearly infinite adjustability and customization.

Comfort & Compliance

Compression style back braces are clinically proven to reduce pain, lessen the need for medications, and increase activity levels. But these benefits can only be achieved if patients are compliant. SLEEQ's approach to comfort and compliance are Best-in-Class. Quinn Medical uses all open-cell foams and aerated panels for breathability and reduced skin moisture; cold molding plastics for an automatically customized anatomical fit; and Quinn Medical was one of the first to use comfortable, ergonomic pull-tabs to make tightening a cinch.



Dual-Zone Technology

The **SLEEQ Dual-Zone Technology** is Quinn's unique approach to the brace wings. An inelastic center section provides stabilizing compression and unparalleled comfort with mild stretch relief at the ribs and hips. This design maximizes compression where you need it with relief where you want it. Effective compression is maintained, even while seated, when there's more pressure on the lumbar anatomy.

Sitting Comfort



LORDOSIS

Even pressure on discs while in a standing position

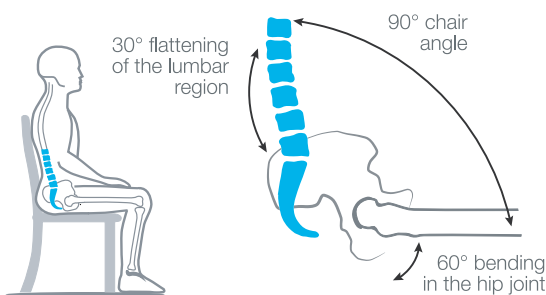

KYPHOSIS

More pressure on the discs when at a right angle sitting position

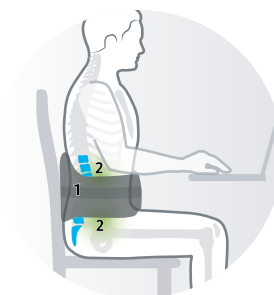

DUAL-ZONE TECHNOLOGY

Maintain effective compression + relief at the ribs and hips



Breathable

Patients stay cool and dry with ventilated support panels and lightweight breathable materials



Proven Pain Relief

SLEEQ compression braces provide safe and effective pain relief without the side-effects of medications.



Made in USA

SLEEQ products are designed and made in the USA with the highest quality components.

Integrated cold/heat therapy

The SLEEQ Spinal Therapy System incorporates cold or heat capability with Q^othermo ComfoWrap™. Simply attach Q^othermo using the exclusive AnchorTab system for the added benefit of cold or heat pain relief, right where it's needed.



ComfoWrap works with all models of SLEEQ back braces



Central fabrication for complex patients

Given the volume and diversity of the custom specialty braces we manufacture, Townsend has developed a level of proficiency that is difficult for O&P providers to replicate in their own shop. We fabricate carbon graphite KAFOs, AFOs and specialty knee braces for your most challenging, complex patients.

Premium Materials



Carbon Graphite

braces feature carbon graphite and composite materials to create a durable, lightweight low profile design.



Aluminum

braces utilize proprietary customized bending techniques to achieve an intimate fit even on disproportional legs.



Thermo-Plastic

braces utilize traditional heating and vacuum forming techniques to achieve maximum control and function.



Knitted

braces have specific anatomical structure that adapt to the patient's morphology during daily activities.



Becker Joints (Available In Stock)

Becker Knee Joints

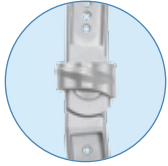

Modular Ring Lock Model 1402-B



Automatic Angled Levered Lock Model 1017-A



Modular Ratchet Lock Model 1018-A

Becker Stance Control



Becker SafetyStride™



Becker FullStride™



Becker Stride4™

Becker Ankle Joints



Double Action Ankle (Model #SLM-2825-A)



Standard Action (Model #3025-A)



Dorsi-Flexion Assist (Model #3225-A)

Townsend Joints

Free Motion Knee Joints



5 Bar Free Knee



Aluminum TM5+



Townsend Original Hinge

Locking Options



Single Pivot With Manual Or Cable Release



5 Bar Trigger Locks With Manual Or Cable Release

Available Colors

See product order forms for standard and optional colors

Rebel Series Braces

Powdercoat Colors

Standard



RelieverOne OA

Powdercoat Colors



Premier Series Braces

Paint Colors

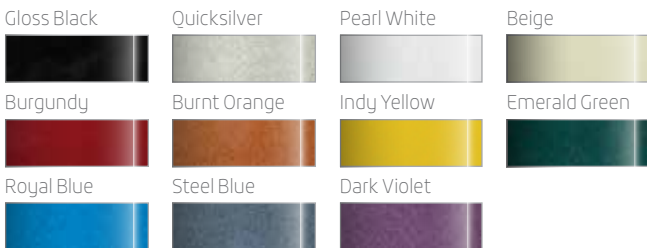

Premier Series Braces

Textured Powdercoat Colors

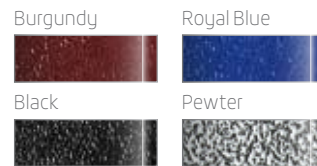

Ankle Joints



Free-Motion



Free-Motion Heavy Duty



Single Adjustable



Double Adjustable



Dorsi Assist



Dorsi Assist With 90° Stop



Single Adjustable With Assist



Double Adjustable With Assist

Full Shell Series Braces

Fabrics/Pigments







Malleoaction

Product #236102

- Provides support and compression
- Anatomically-shaped elastic knit for optimal malleoli comfort
- Patented pull tabs for easy application and removal
- 22 mmHg

Size	Ankle Circumference
1	7 1/2 - 8 1/4 inch
2	8 1/4 - 9 inch
3	9 - 9 3/4 inch
4	9 3/4 - 10 3/4 inch
5	10 3/4 - 11 3/4 inch





Malleo Go

Product #T300202

- Provides support and compression
- Anatomically-shaped elastic knit for optimal malleoli comfort
- Silicone inserts for malleoli protection
- Available in left or right

Size	Ankle Circumference
1	6 3/4 - 7 1/2 inch
2	7 1/2 - 8 1/4 inch
3	8 1/4 - 9 inch
4	9 - 9 3/4 inch
5	9 3/4 - 10 3/4 inch
6	10 3/4 - 11 3/4 inch





Ligastrap Malleo

Product #218003

- Figure 8 strapping provides lateral stabilization and support
- Removable reinforcement strap
- Anti-slip system prevents migration
- Patented pull tabs for easy application and removal
- Low profile for maximum comfort
- 27 mmHg

Size	Ankle Circumference
1	7 1/2 - 8 1/4 inch
2	8 1/4 - 9 inch
3	9 - 9 3/4 inch
4	9 3/4 - 10 3/4 inch
5	10 3/4 - 11 3/4 inch





Silistab Achillo

Product #235502

- Soft silicone heel insert offloads achilles tendon obtaining instant relief
- Dimpled achilles silicone insert provides tendon protection and massage
- Anatomically-shaped elastic knit for optimal malleoli comfort
- Inserts available in 3 heights
- Patented pull tabs for easy application and removal
- 23 mmHg

Size	Ankle Circumference
1	7 1/2 - 8 1/4 inch
2	8 1/4 - 9 inch
3	9 - 9 3/4 inch
4	9 3/4 - 10 3/4 inch
5	10 3/4 - 11 3/4 inch





Ligacast Air+

Product #233401

- Rigid side shells deliver firm support
- Inflatable inserts reinforce protection and help reduce swelling
- Adjustable heel and Velcro straps for easy application
- Additional inflator bulb for air pressure customization after brace is fit



Single Size

PDAC Approved L4350

Ligacast Anatomic

Product #231501

- Rigid side shells deliver firm support
- Asymmetrical malleoli prominence and flexible edges allow for anatomical fit
- Honeycomb interior for enhanced patient comfort



PDAC Approved L4350

Size	Patient Height	
0	< 5' 3" inch	
1	> 5' 3" inch	

Available in left or right

Ligastrap Immo

Product #233702

- Rigid side shells deliver firm support
- Thermoregulating Outlast® fabric inner lining for long-term use and comfort
- Pulley system allows simplified fastening and precise adjustment of the brace
- Asymmetrical malleoli prominence and flexible edges allow for anatomical fit
- Removable strap provides additional support



PDAC Approved L4350

Size	Patient Height	
0	< 5' 3" inch	
1	> 5' 3" inch	

Available in left or right



Maximum stabilization

- Light, comfortable and strong metallic splint
- Additional straps

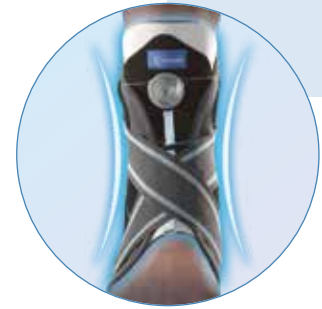

Low profile

- Streamlined design (enables brace to be worn in any type of shoe)

Malleo Dynastab Boa™

Product #235101

Practical

- Fast, easy and reliable Boa® tightening system, with a lifetime guarantee
- Wide opening offers easy application and removal

Immobilization

- Resistant and comfortable lightweight metal reinforcements
- Figure 8 strapping system provides additional lateral reinforcement

Comfort

- Lightweight and comfortable antibacterial-treated 3D knit for effective moisture-wicking
- Slim low-profile design allows the brace to be worn in most types of shoes

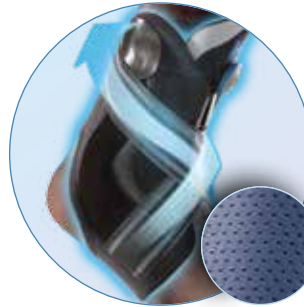

Optimum comfort

- Anatomic design features micro-aerated 3D fabric



Easy fitting

- Boa® closure system: easy, quick and Dialed In For Life™ guarantee

PDAC Approved L1902

Size	Ankle Circumference
1	7 1/2 - 8 3/4 inch
2	8 3/4 - 10 1/4 inch
3	10 1/4 - 11 3/4 inch





Malleo Dynastab

Product #235001

- Precise lace-up tightening
- Same features and benefits as Malleo Dynastab Boa™

PDAC Approved L1902

Size	Ankle Circumference
1	7 1/2 - 8 3/4 inch
2	8 3/4 - 10 1/4 inch
3	10 1/4 - 11 3/4 inch





Walking Boots

XLR8 (Accelerate) Series

Features

- Molded plastic shell with anterior plate
- Pneumatic bladder with built in air pump
- Molded/padded insole
- Shock absorbing outer sole rocker
- Foam bootie
- Non-elastic straps
- Patented adjustable toe guard (3 Space Positions)

Options

- Full height or mid calf
- Heel wedges
- Indoor sanitary outer sole cover

Ordering

- XLR8: XS-XL

Size	Men's Shoe Size	Women's Shoe Size
XS	2 - 4	3 1/2 - 5
SM	4 - 7	5 - 8
MD	7 - 10	8 - 11
LG	10 - 13	11 - 15
XL	13 - 16	15+

Townsend's Stability Boot Series provides a range of models and ordering options, including rigid metal shell walkers and economical plastic shell walking boots



XLR8 Full Shell Walker



XLR8 Mid Calf Full Shell Walker

Walking Boots

EZG8 (Easy Gait) Series

Features

- Foot shell
- Aluminum uprights (EZG8 and EZG8 ROM Walkers)
- Molded/padded insole
- Shock absorbing outer sole rocker
- Foam bootie
- Non-elastic straps

Options

- Plastic foot shell
- Full height or mid calf uprights
- ROM hinges (EZG8 ROM Walker)
- Standard or pneumatic (air bladder) bootie
- Heel wedges (for XLR8 and EZG8)
- Indoor sanitary outer sole cover

Ordering

- EZG8: XS-XL
- EZG8 ROM: XS-XL

Size	Men's Shoe Size	Women's Shoe Size
XS	2 - 4	3 1/2 - 5
SM	4 - 7	5 - 8
MD	7 - 10	8 - 11
LG	10 - 13	11 - 15
XL	13 - 16	15+

Townsend's Stability Boot Series provides a range of models and ordering options, including rigid metal shell walkers and economical plastic shell walking boots



EZG8 Mid Calf Walker



EZG8 ROM



EZG8 Walker

Achilles/Adjusta Walker

Features

- Bendable metal uprights
- Softer, durable rocker bottom
- Patented sliding upright ensures the most customized fit
- Enhances correct ankle alignment and natural gait
- Soft inner foot bed
- Posterior StableLock shell prevents heel slippage

Options

- Pneumatic and non-pneumatic versions

Ordering

- S-XL

Size	Men's Shoe Size	Women's Shoe Size
SM	3 1/2 - 7	4 1/2 - 8
MD	7 - 10	8 - 11
LG	10 - 13	11 - 15
XL	13 - 16	15+



Adjustable Uprights

Both uprights can be positioned to align with mid line on the leg, optimizing natural gait.

Night Splint

Features

- Ventilated, lightweight medical grade plastic shell configuration
- Adjustable, non elastic resistant straps allow continuous calm stretching protocols
- Open cell foam liner is washable and semi-permeable to eliminate excessive heat absorption
- Comfortable, non-irritable strap pads help protect against discomfort on boney anatomy
- Easy to use, convenient center release buckles
- Non-slip outer sole
- Standard sizes (based on patient's shoe size)



Ordering

- S-LG

Recommended L-Code 4396

Size	Men's Shoe Size	Women's Shoe Size
SM	3 1/2 - 7	4 - 7 1/2
MD	7 - 10	8 - 10 1/2
LG	10 1/2 - 13	10 1/2 - 15

NOX Splint

Features

- Hinge design allows for individual comfort and outcomes
- Adjustable tension strap
- Position indicator window
- Well padded (strategic interior air bladder)
- Wider metatarsal region
- Non-skid sole



Options

- Optional accessory strap

Ordering

- S - XL

Size	Men's Shoe Size	Women's Shoe Size
SM/MD	5 - 9	6 - 10
LG/XL	9 1/2 - 14	10 1/2 - 15



SpryStep[®] Dynamic AFO

Features

- Lightweight, durable composite construction engineered with unique laminated characteristics to prevent fracture and breakage
- Material diversity offers strategic flexibility and stiffness to enhance performance and patient comfort
- Proprietary posterior lateral position of the strut increases patient compliance and energy return for activity reengagement
- Superior cosmetic finish
- Practitioner-friendly and adjustable

The blue sides and toe of the SpryStep's forefoot can be trimmed with scissors



PDAC Approved L1951

Size	Height	Foot Length
XS	11 3/4 inch	8 1/2 - 9 5/8 inch
SM	12 5/8 inch	9 1/8 - 10 1/4 inch
MD	13 3/8 inch	9 5/8 - 10 7/8 inch
LG	14 1/8 inch	10 1/4 - 11 3/8 inch
XL	15 inch	11 3/8 - 12 inch



Premier AFO

Townsend's Premier AFO is a low profile, lightweight brace that provides exceptional control for instabilities while optimizing the patient's alignment and potential range of motion.

Unlike traditional thermoplastic AFOs, the solid core, carbon graphite construction is more rigid and durable – providing superior functionality. The brace can be manufactured with a variety of Townsend or Becker Orthopedic ankle joints, and the foot plate construction can be carbon or thermoplastic.

Potential Users

- Posterior tibial tendon dysfunction
- Global ankle instabilities
- CVA/drop foot
- Partial paralysis
- Charcot deformity
- Ankle fractures

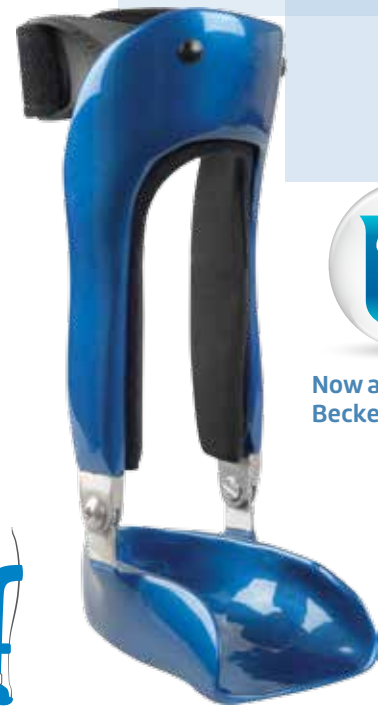
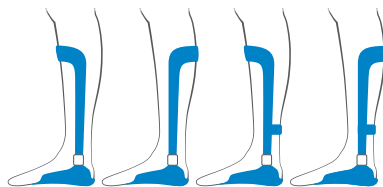

Now available with
Becker ankle joints



Thermo-Plastic Solutions

With an increasing number of O&P facilities relying on external suppliers, Townsend has evolved its fabrication capabilities to offer a full range of thermo-plastic specialty braces.

AFOs, KAFOs and KOs are fabricated from a hand-modified positive model (we accept casts or digital scans), using traditional vacuum-forming methods to ensure patient comfort and quality cosmetic finish. Offered with a complete range of knee and ankle joints, the thermo-plastic braces are an economical solution for patients who have volume fluctuations, and enable qualified O&P practitioners to make fitting adjustments to the shells and metal components without having to return the product to the factory.

Premier Ankle Brace

Townsend Premier Ankle Braces combine an anterior or posterior tibia containment shell with a thermo-plastic (or carbon) foot plate, offering a significant level of functional control and durability.

This product is extremely successful for patients who are compromised by instabilities and posterior tibial tendon dysfunction. These ultra low profile braces incorporate unique hinges that are integrated seamlessly into the structure. The standard hinges come with a set of easy-to-install inserts to restrict inversion and eversion motion. Compared to traditional gauntlet style braces, the Premier Ankle Brace provides comfortable stabilization WITHOUT ANY LIMITATION to normal plantarflexion and dorsiflexion motion.

Potential Users

- Instability, inversion and eversion issues
- Chronic ankle instabilities and some forms of arthritis
- Posterior tibial tendon dysfunction
- Elite athletes with an injured ankle or at high risk for injury
- Severe Pes Planus (flat foot, if a UCBL has failed)

Ordering Options

Premier Ankle Braces can be ordered with anterior or posterior shells, and with a variety of foot plate options. Premier Ankle Braces with standard ankle joints include inserts that can fixate the joints or limit inversion/eversion.



Premier-PTS
(Posterior Tibia Shell)

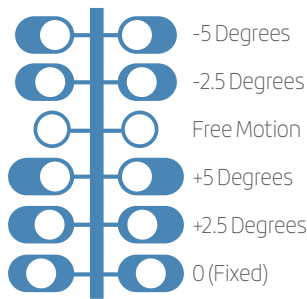

Standard
Ankle Joints



Standard Ankle Joints With
Optional Dorsi Assist Bands



Optional
Tamarack Joints



Optional Dorsi
Assist Bands



Premier-ATS
(Anterior Tibia Shell)



Premier-PTS/TJ
(Posterior Tibia Shell
& Tamarack Joints)



Polypro-PTS
(Posterior Tibia Shell)



Premier-SU/ATS
(Single Upright with
Anterior Shell)



Genu PRO ACTIV®

Product #U31001

For maintenance, compression and support of the knee after mild or moderate knee strains or sprains.

Maximum Efficacy

- Patented silicone patellar insert
- Medical grade compression reinforces proprioception (26mmHg)
- Double upright hinges provide additional stability

Optimum Comfort

- Soft knit over the popliteal crease
- Anatomical cut at the calf
- Low-profile design

Excellent Suspension

- 3D knitting perfectly adapting to morphology
- Lateral silicone bands

PDAC Approved L1810/L1812

Size	Thigh Circumference 5 1/2" above knee	Calf Circumference 4 3/4" below knee
1	13 3/4 - 15 inch	9 3/4 - 11 inch
2	15 - 16 1/4 inch	11 - 12 1/4 inch
3	16 1/4 - 17 1/4 inch	12 1/4 - 13 1/2 inch
4	17 1/4 - 18 1/2 inch	13 1/2 - 14 1/2 inch
5	18 1/2 - 20 inch	14 1/2 - 16 1/4 inch
6	20 - 21 3/4 inch	16 1/4 - 17 3/4 inch
6+	21 3/4 - 23 1/4 inch	17 3/4 - 18 1/2 inch



Patented Patellar Insert



3D Knitting



Genuxtrem

Product #232101

- Provides support and compression
- Flexible lateral stays give additional reinforcement
- Anatomically-shaped elastic knit for optimal thigh, calf, and popliteal comfort
- Lateral silicone anti-slip system for better hold
- Patented pull tabs for easy application and removal
- 28 mmHg

Size	Knee Circumference
1	12 1/2 - 13 1/2 inch
2	13 3/4 - 14 1/2 inch
3	15 - 16 1/4 inch
4	16 1/2 - 17 3/4 inch
5	18 - 19 1/4 inch
6	19 3/4 - 20 3/4 inch



Patellar Strap

Product #230401

- Applies local pressure over the patellar tendon and supports the kneecap due to its anatomical shape

Single Size

10 1/4 - 19 1/2 inch



Genu Ligaflex® ROM

Product #238604

For patients with mild to moderate ligament injuries and instabilities, early stage OA, meniscus injuries/post-operative meniscal repairs. Available in pull-on and anterior closure models in 12" and 16" lengths.

Easy to Use

- Anterior opening for easy application
- Easy to use Velcro tabs
- Low profile tension buckles

Suspension

- TM5+ hinge that replicates the natural movement of the knee
- Exclusive Synergistic Suspension Strap
- Patented integrated anti-slip silicon knitting
- Tool-less hinge with easy to apply flexion and extension stops to restrict range of motion

Practitioner Friendly

- Contoured aluminum uprights to improve fit and control
- Medical grade compression

PDAC Approved L1832/L1833



Size	Knee Circumference
1	12 ½ - 13 ¾ inch
2	13 ¾ - 15 inch
3	15 - 16 ½ inch
4	16 ½ - 18 inch
5	18 - 19 ¾ inch
6	19 ¾ - 21 inch





Silistab Genu

Product #234005

- Provides support and compression
- Patented silicone patella insert provides kneecap support and protects the patella tendon
- Breathable cotton fabric integrated posteriorly
- Flexible lateral stays give additional reinforcement
- Anatomically-shaped elastic knit for optimal thigh, calf, and popliteal comfort
- Lateral silicone anti-slip system for better hold
- 18 mmHg

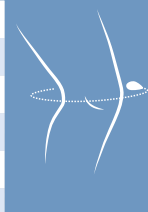
Size	Knee Circumference
1	12 ¼ - 13 inch
2	13 ½ - 14 ¼ inch
3	14 ½ - 15 ¼ inch
4	15 ¾ - 16 ½ inch
5	17 - 17 ¾ inch
6	18 - 19 inch





Ligastrap Genu

Product #217002

- Provides support and compression
- Numbered figure eight strapping delivers extra stabilization
- Anatomically-shaped elastic knit for optimal thigh, calf, and popliteal comfort
- Patented pull tabs for easy application and removal
- 26 mmHg

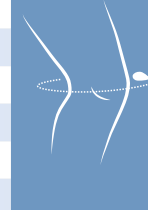
Size	Knee Circumference
1	12 ½ - 13 ½ inch
2	13 ¾ - 14 ½ inch
3	15 - 16 ¼ inch
4	16 ½ - 17 ¾ inch
5	18 - 19 ¼ inch
6	19 ¾ - 20 ¾ inch



Genu Ligaflex®

Product #237504

For resumption of non-contact sports and activities of daily living after mild or moderate knee injuries

Comfort

- Hyper-flexible knitted areas:
 - Popliteal space
 - Patella
 - Thigh
- Semi-rounded straps for easy application
- Pre-contoured uprights provide anatomical fit

Support

- Aluminum uprights provide lateral stability
- Double adjustable Velcro tabs optimize placement of uprights

Suspension

- TM5 Hinge mimics the natural roll and glide motion of the knee
- Aggressive dual tab calf strap improves suspension
- Integrated anti-slip silicone located inside
- Dual tab strapping system allows for a precise fit
- Flexible knitting improves mobility and ease of application



Pull-on short version (12")

Pull-on long version (16")

PDAC Approved L1820

Size	Knee Circumference
1	12 ½ - 13 ½ inch
2	13 ¾ - 14 ½ inch
3	15 - 16 ¼ inch
4	16 ½ - 17 ¾ inch
5	18 - 19 ¼ inch
6	19 ¾ - 20 ¾ inch



Genu Ligaflex OPEN

- Opening in the front
- Easy position patellar ring
- Low profile tension buckles



Open long version (16")

Open short version (12")



Genu Dynastab

Product #237005

- Dual hinge design provides maximum stability
- Semi-rigid strapping gives extra support and prevents migration
- Patented pull tabs for easy application and removal

PDAC Approved L1820

Size	Knee Circumference
1	12 ½ - 13 ½ inch
2	13 ¾ - 14 ½ inch
3	15 - 16 ¼ inch
4	16 ½ - 17 ¾ inch
5	18 - 19 ¼ inch
6	19 ¾ - 20 ¾ inch

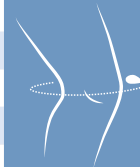



ROMX and ROM Series

Post-Op Knee Braces

Patients who require post-operative fixation and/or range of motion control for post-injury stabilization.

Features

- Rigid aluminum bars
- Hinges with adjustable extension & flexion stops
- Drop lock mechanism

Options

- Bar length
- Shell pads (Full, Air, or Breeze)
- Straps with Velcro or buckle closures
- ROMX.SS and ROMX.BP feature suspension optimizing (anti-migration) technology

Ordering

- OTS, variety of models and lengths
- Universal size, no measurements required.
- Full shell pads available for thigh circumference over 30 inches

ROMX Series



ROMX.SS

Traditional ROM Series



AIR ROM LONG



ROMX Hinge



Traditional ROM Hinge

Braces available with ROMX Hinges:

- ROMX.SS
- ROMX.BP
- ROMX.FP
- ROMX.AP

Braces available with Traditional ROM Hinges:

- AIR ROM short
- AIR ROM long
- ROM 4
- ROM 6

ROM-R

Customizable Stabilization

The ROM-R is routinely prescribed for patients who require post-operative fixation and/or range of motion control for post-injury stabilization.

Features

- ROM hinges with drop locks and tool-free adjustable flexion and extension settings
- Sturdy aluminum struts with extendable ends that telescope from 19" to 22"
- Easy to adjust
- Comfortable and light weight
- Malleable paddles with individual cool pads can be contoured to the leg to achieve an intimate fit, increase stabilization and improve brace suspension
- 2000 cycle straps with Velcro tabs



Knee Immobilizer

Product #155001

- Provides comfortable full extension knee immobilization
- Expandable circumference accommodates leg size

Suggested Code L1830

Size	Knee Circumference
1	19 3/4 - 23 1/2 inch
2	23 1/2 - 27 1/2 inch
3	27 1/2 - 31 1/2 inch
4	> 31 1/2 inch



Genuimmo 0°

Product #241501

- X-ray friendly, radio-transparent conformable rigid stays
- Height adjustable straps for an anatomical fit
- Easy access to the knee for post surgical care
- Open design allows for lightweight, breathable comfort and ease of use

Suggested Code L1830

Size	19 3/4 inch height Under 5 ft - 9 inch	23 1/2 inch height Over 5 ft - 9 inch
SM	13 3/4 - 17 3/4 inch	-
MD	17 3/4 - 20 1/2 inch	17 3/4 - 20 1/2 inch
LG	20 3/4 - 24 1/2 inch	20 3/4 - 24 1/2 inch
XL	24 3/4 - 29 1/2 inch	24 3/4 - 29 1/2 inch

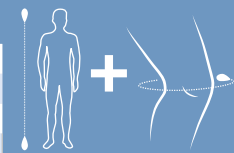





Sport Series

Patients who have experienced mild ligament injuries and/or reconstructive knee surgery.

Features

- Compression sleeve
- Pull on or anterior closure models
- Townsend Motion Hinges
- Rigid aluminum bars
- Reinforced nylon hinge pockets (no exposed metal)
- Condylar pads
- OTS, S-4X (4X only offered in neoprene)

Options

- Latex-free neoprene sleeve material or fiber-cool spacer fabric sleeve material
- 12 Inch (2 strap) and 16 inch (4 strap) models
- Two hinge options
- Extension stop kit
- Flexion stop kit



TS ROM 1200/1600

Patients who have experienced mild ligament injuries and/or reconstructive knee surgery.

Features

- Compression sleeve
- Pull on or anterior closure sleeves
- Townsend ROM control hinges
- Rigid aluminum bars
- Extension stop kit
- Flexion stop kit
- Reinforced nylon hinge pockets
- Condylar pads
- OTS, S-4X (4X only offered on neoprene)

Options

- Latex-free neoprene sleeve material or fiber-cool sleeve material
- 12 Inch (2 strap) and 16 inch (4 strap) models
- Patella buttress (pull-on sleeves)

Size	Knee Circumference
SM	13 - 14 inch
MD	14 - 15 inch
LG	15 - 17 inch
XL	17 - 19 inch
2X	19 - 21 inch
3X	21 - 22 inch
4X	22 - 23 inch





BOLD

Patients who have experienced ligament injuries and/or reconstructive knee surgery.

Features

- Lightweight brushed aluminum frame with black polymer cuffs
- Townsend Motion TM5+ Hinges
- Exclusive Synergistic Suspension Strap
- 14 Inch length
- Extension stop kit
- Anti-migration strap padding

Options

- Flexion stop kit
- Knee guard

Ordering

- OTS: S to XL



Size	7" above	7" below	
SM	15½ - 18½ inch	12¼ - 13¾ inch	
MD	18½ - 21 inch	13¼ - 15 inch	
LG	21 - 23½ inch	14¼ - 15¾ inch	
XL	23½ - 25 inch	15 - 17 inch	



Rebel Ligament Braces

Patients who have experienced ligament injuries and/or reconstructive knee surgery.

Features

- Rigid aircraft aluminum frame
- Townsend Motion TM5+ Hinges
- Extension stop kit
- Exclusive Synergistic Suspension Strap
- Rotation control tibial shell contour
- Powdercoat finish

Options

- Rebel Lite (lowest weight, less rigid)
- Rebel (ideal for most patients)
- Rebel PRO (heavy users and contact sports)
- Anti-migration strap padding
- ACL or combined instabilities
- 13 (Rebel Lite), 14, 15 and 16 inch length
- Compression/Suspension anti-migration package
- Flexion stop kit
- A variety of colors
- Standard OTS sizes XS to XL (XXL Pro model)
- "Custom assembled" from 3 leg measurements
- Custom from a cast, digital leg scan, Custom Configuration System (photos)



When ordering custom or from 3-leg measurements

Vast range of ordering options

Optional shell configurations

The Rebel is available in a variety of custom shell configurations.



MC thigh, available on the Rebel PRO model, has increased surface contact for added stabilization.



Optional posterior tibia shell.

Size	6" above	M-L width	6" below
XS	12½ - 15½ inch	3 - 3½ inch	11 - 12½ inch
SM	15½ - 18½ inch	3½ - 4 inch	12¼ - 13¾ inch
MD	18½ - 21 inch	4 - 4½ inch	13¼ - 15 inch
LG	21 - 23½ inch	4½ - 5 inch	14¼ - 15¾ inch
XL	23½ - 25 inch	5 - 5½ inch	15 - 17 inch
XXL	25 - 28 inch	5½ - 6 inch	17 - 19 inch
XXXL	28 - 31 inch	< 6 inch	

Three leg measurement

- Custom assembly for disproportional legs, no additional fee

Premier Series

Patients who have experienced ligament injuries and/or reconstructive knee surgery.

Features

- Custom molded solid core carbon graphite shells
- Townsend Motion TM5+ Hinges
- Extension stop kit
- Exclusive Synergistic Suspension Strap
- Rotation control tibial shell contour
- High gloss paint or powdercoat finish

Options

- ACL or combined instabilities
- Anti-migration strap padding
- 13, 14, 15 and 16 inch shell length
- Hinge material -- aluminum or stainless
- Compression/suspension anti-migration package
- Flexion stop kit
- A variety of colors

Ordering

Custom from a cast, digital leg scan, or Custom Configuration System (photos)



Optional Extension Assistance

Mechanism uses strong latex bands slipped over two posts -- one proximal and one distal -- to the knee center. There is no limitation in flexion.

Optional shell configurations

The premier is available in a variety of custom shell configurations.



Standard Thigh Shell



Posterior Tibia Shell



Double Band Tibia



Single Upright Extension

KAFO with leg extension and heel cup for rotary control or to eliminate potential brace migration

Air Townsend & Air Lite

Patients who desire or require maximum control after experiencing a ligament injury and/or reconstructive knee surgery.

Features

- Custom molded laminated carbon graphite shells
- Townsend Motion TM5+ Hinges
- Extension stop kit
- Exclusive Synergistic Suspension Strap
- Anti-rotation tibia shell bolster (Air Townsend)

Options

- Non-standard length shells
- Anti-migration strap padding
- Hinge material – aluminum or stainless
- Special trim lines for skiers, rodeo riders, hockey goalies, and full figure model for soft tissue containment
- Flexion stop kit
- A variety of colors or fabric inlay

Ordering

- Custom from a cast or digital leg scan

Optional Extension Assistance

This mechanism uses strong latex bands slipped over two posts – one proximal and one distal – to the knee center. There is no limitation in flexion.

Single Upright Extension

KAFO with leg extension and heel cup for rotary control or to eliminate potential brace migration

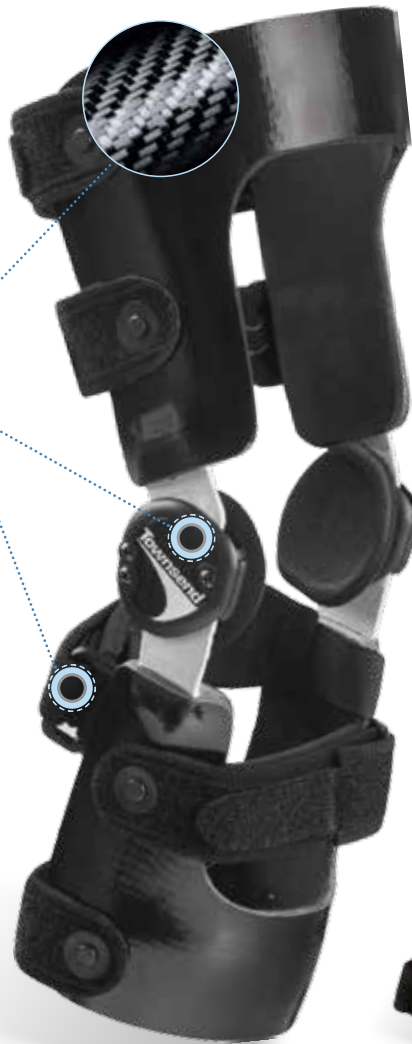

The Air Lite features an adjustable anterior tibia strap and narrower bands to reduce the weight and profile of the brace.



The Air Townsend is a traditional full shell design that provides maximum control and protection for ligament instabilities.

Motocross Series

Motocross riders who have experienced ligament injuries and/or reconstructive knee surgery, or to help prevent knee injuries.

Features

- Custom molded laminated carbon graphite shells
- Townsend Motion TM5+ Hinges
- Extension stop kit
- Exclusive Synergistic Suspension Strap (Motocross Air)
- Second shell pad with no patella guard
- Anti-migration strap padding

Options

- Shell length (Motocross Air)
- Hinge material – aluminum or stainless (Motocross Air)
- Flexion stop kit
- A variety of colors or fabric inlay (Motocross Air)

Ordering

- Custom from a cast or digital leg scan



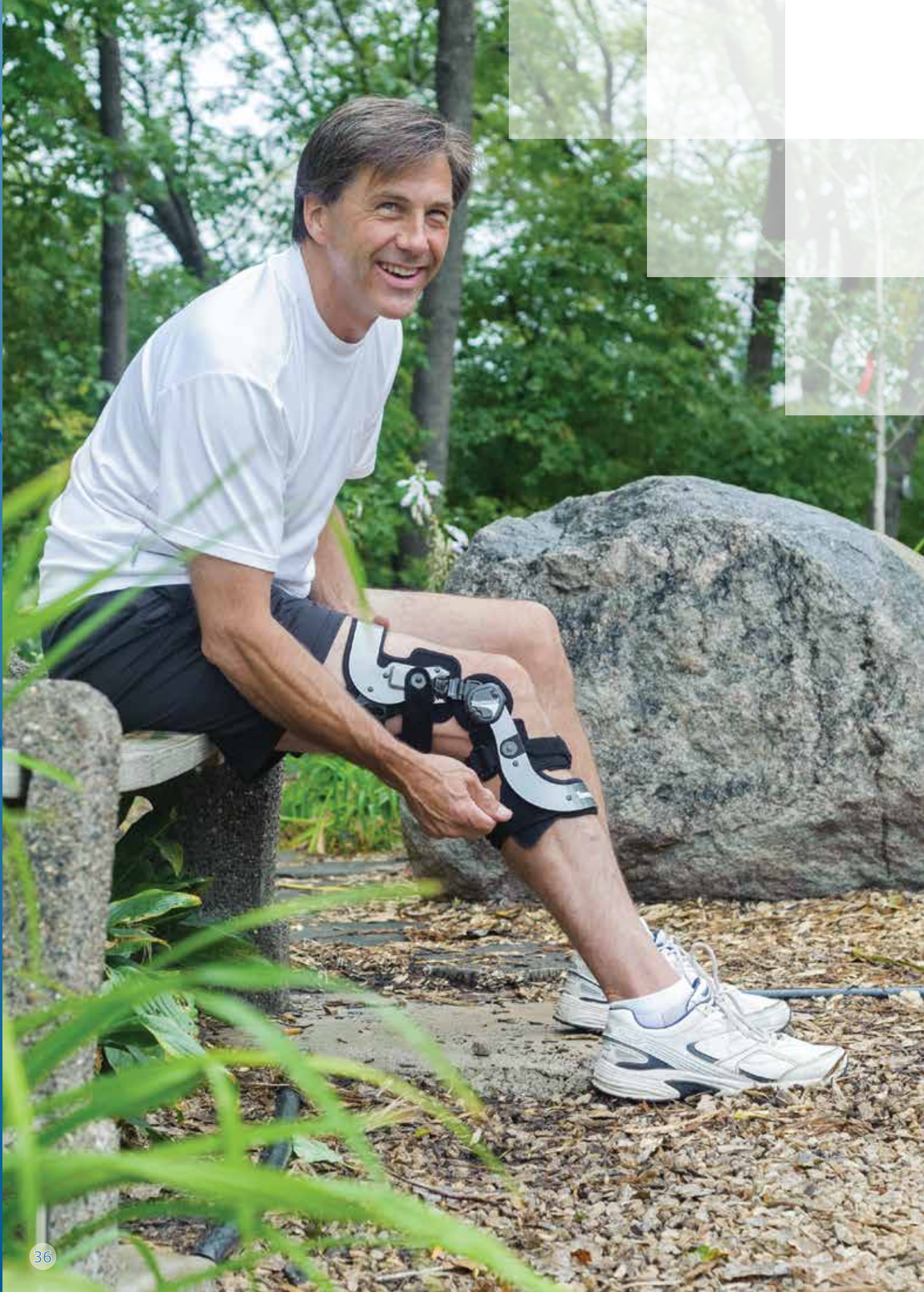

Softforce Reliever

Patients with mild to moderate medial or lateral OA who are more compatible with a less rigid knee brace that offers compression and comfortable leg alignment support.

Features

- Latex-free fiber cool compression sleeve
- Townsend Motion TM6 Hinge
- Two internal hinge pockets (no exposed metal)
- Adjustable aluminum bar with paddles
- Condylar pads
- Extension stops

Options

- Medial or lateral OA
- Option of lateral hinge position for lateral OA
- Flexion stop kit

Ordering

- OTS: XS to 4XL

Size	Knee Circumference
XS	12 - 13 inch
SM	13 - 14 inch
MD	14 - 15 inch
LG	15 - 17 inch
XL	17 - 19 inch
2X	19 - 21 inch
3X	21 - 22 inch
4X	22 - 23 inch



Townsend's SoftForce provides comfortable correction and inflammation-reducing compression.



Hinge/Bar Assembly

The SoftForce can be configured for medial or lateral OA. The aluminum bar and hinge assembly inserts into an internal pocket. For stock inventory, the brace can be used universally by shifting the hinge to the pocket in the opposite side of the brace.



Extra Large Thigh Opening

The thigh section features a unique anterior closure that creates a wide opening. This feature makes the brace extremely easy to pull on and tighten.

Active Reliever

Unicompartment osteoarthritis, articular cartilage defect repair, meniscal cartilage repair or osteochondral defect repair.

Features

- Breathable spacer fabric sleeve with posterior expandable Lycra panel
- Anatomically correct roll-and-glide Townsend Motion Hinge with adjustable ROM stops
- Semi-rigid, self-contouring nylon superstructure sewn into the sleeve
- Bendable bar for customization of the fit and counterforce
- Corrective Force Strap applies maximum counterforce at midstance phase of gait
- Patient friendly quick release buckles
- Open anterior thigh section for easy donning and doffing

Options

- Medial or lateral OA
- Left or right hinge position

Ordering

- OTS: XS - 3XL

Unique Features



Adaptable patella buttress pad



Interior thigh panel can be removed and trimmed for custom fitting



Ergonomically designed quick release buckles make it easier for the patient to apply and remove the brace



Size	6" above mid Patella	6" below mid patella	
XS	13 - 15 inch	10 - 12 inch	
SM	15 - 18 inch	12 - 14 inch	
MD	18 - 21 inch	14 - 16 inch	
LG	21 - 23 inch	16 - 18 inch	
XL	23 - 26 inch	18 - 20 inch	
XXL	26 - 29 inch	20 - 22 inch	
XXXL	29 - 32 inch		

Adjustable Corrective Force Technology

- Increase/decrease correction
- Even distribution of corrective force pressure

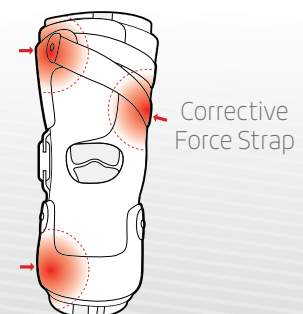

Dynamic Reliever

Patients with mild to moderate medial OA who are more compatible with a less rigid knee brace that offers compression and comfortable leg alignment support. The semi-malleable shells conform to normal size or disproportional size legs.

Self-Contouring Nylon Shells

- Ensures an intimate, comfortable fit
- Optimizes delivery of corrective forces
- Prevents brace migration

Premium Soft Adjustable Straps

- No bulky strap padding required
- Strap length is adjustable from either end

Dynamic Telescopic Hinge

- Exclusive Townsend Motion tracks with the roll-and-glide translation of the knee
- Automatically telescopes inward as knee extends
- Delivers maximum correction at mid-stance phase of gait

Adjustable Tibia Shell Bolster

- Fitter makes one-time adjustment to tool-less movable bolster
- Captures and locks on the tibia better than other braces
- Prevents the brace from rotating as correction is applied

Speed Klips™ Connect Straps To Shell

- User friendly buckles
- Easy for patients to put on and take off the brace



Size	Thigh Circumference 6" above mid patella	Calf Circumference 6" below mid patella
1	14 - 18 inch	11 - 14 inch
2	18 - 24 inch	14 - 17 inch
3	23 ½ - 28 inch	17 - 19 inch

The Dynamic Reliever is the perfect medial OA brace for disproportioned legs

Dynamic Telescopic Hinge



Adjustable Anti-Rotation Tibial Bolster

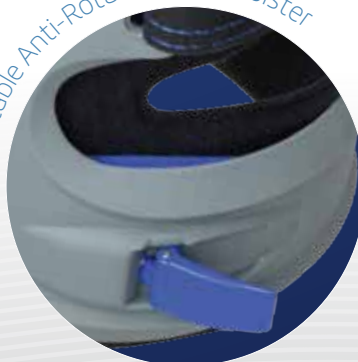

Premium Straps with Speed Klips™



RelieverOne & UniReliever

Patients diagnosed with mild to moderate medial or lateral OA.

Features

- Aircraft aluminum frame
- Townsend Motion Hinge
- Extension stop kit
- Adjustable correction
- Exclusive Synergistic Suspension Strap
- Anti-migration strap padding
- Rotation control tibial shell contouring

Options

- Medial or lateral OA models
- Shell length
- Flexion stop kit
- Optional colors

Ordering

- Custom assembled from 3 leg measurements for disproportional legs
- Custom from a cast, digital leg scan, or Custom Configuration System (photos)
- Powdercoat finish: Reliever One (gloss black or silver), Uni (matte black)
- Standard OTS sizes XS to XXL (RelieverOne thigh shell available in XXXL)

Adjustable Corrective Force Technology

- Increase/decrease correction
- Even distribution of corrective force pressure
- Adjustable force buttress

Best for Medial OA



The RelieverOne is a single upright aircraft aluminum brace that is light weight and low profile. This brace features an adjustable paddle for comfortable distribution of corrective force.

Ideal for Lateral OA



The UniReliever is a single upright rigid aircraft aluminum brace that utilizes an adjustable force buttress. This is an ideal solution for lateral OA patients (hinge is positioned adjacent to the affected compartment).

Size	6" above	M-L width	6" below
XS	12½ - 15½ inch	3 - 3½ inch	11 - 12½ inch
SM	15½ - 18½ inch	3½ - 4 inch	12¼ - 13¾ inch
MD	18½ - 21 inch	4 - 4½ inch	13¼ - 15 inch
LG	21 - 23½ inch	4½ - 5 inch	14¼ - 15¾ inch
XL	23½ - 25 inch	5 - 5½ inch	15 - 17 inch
XXL	25 - 28 inch	5½ - 6 inch	17 - 19 inch
XXXL	28 - 31 inch	< 6 inch	

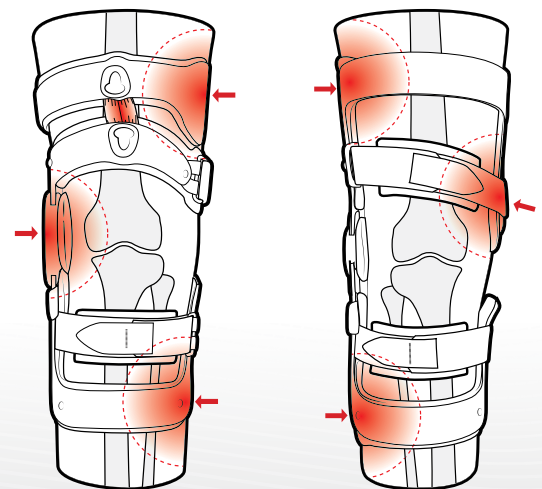

RelieverOne

UniReliever

Rebel Reliever

Patients diagnosed with mild to moderate medial or lateral OA, as well as patients who have OA in combination with ligament instability.

Features

- Rigid aircraft aluminum frame
- Patented adjustable Loadshifters
- Townsend Motion TM5+ Hinges
- Extension stop kit
- Exclusive Synergistic Suspension Strap
- Rotation control tibial shell contour
- Powdercoat finish

Options

- Shell length
- Compression/Suspension anti-migration package
- Anti-migration strap padding
- PCL strap
- Flexion stop kit
- A variety of colors

Ordering

- Standard OTS sizes S to XXL (tibia shell available in XS)
- "Customized" from 3 leg measurements
- Custom from a cast, digital leg scan, tracing, CAS measurement device, or Custom Configuration System (photos)



Large range of ordering options



Townsend's Rebel Reliever OA knee brace has been clinically proven to reduce compressive forces in the knee by 36%. Other clinically proven benefits:

- Improved Walking Capacity
- Improved Muscle Function
- Reduced Compressive Forces
- Improved ADL Participation
- Reduced Symptoms
- Reduced Pain
- Improved Quality of Life
- Improved Balance Confidence

Size	6" above	M-L width	6" below
XS	12½ - 15½ inch	3 - 3½ inch	11 - 12½ inch
SM	15½ - 18½ inch	3½ - 4 inch	12¼ - 13¾ inch
MD	18½ - 21 inch	4 - 4½ inch	13¾ - 15 inch
LG	21 - 23½ inch	4½ - 5 inch	14¼ - 15¾ inch
XL	23½ - 25 inch	5 - 5½ inch	15 - 17 inch
XXL	25 - 28 inch	5½ - 6 inch	17 - 19 inch

Custom Fit From Three Measurements

Rebel Reliever braces ordered from 3 measurements accommodate patients with disproportional leg sizing. Standard braces made from only one leg measurement do not accommodate for patients who have disproportional legs.

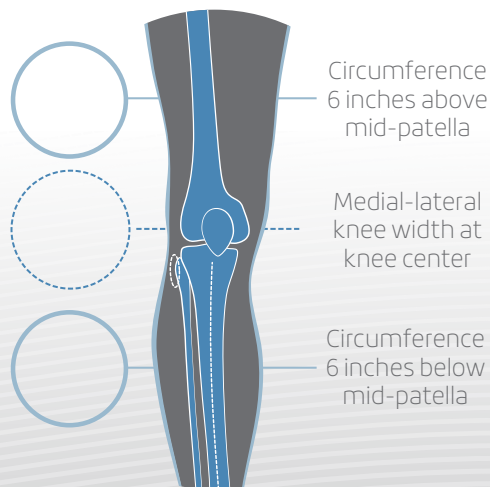

Corrective Force Technology

The uprights can be shortened and/or lengthened to shift the thigh shell angle up to 18 degrees. Increasing corrective force at the proximal end amplifies the affect of the three-point pressure system.

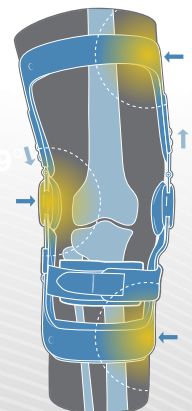

Premier Reliever & PR1

Patients who have moderate to severe medial or lateral unicompartent osteoarthritis. The double upright model is recommended for combination OA and ligament instability. The single hinge PR1 is ideal for lateral OA.

Features

- Custom molded solid core carbon graphite shells
- Townsend Motion TM5+ Hinges (double upright)
- Townsend Motion TM6 Hinge (single upright)
- Extension stop kit
- Exclusive Synergistic Suspension Strap
- Rotation control tibial shell contour
- High gloss paint or powdercoat finish

Options

- 14, 15 and 16 inch shell length
- Anti-migration strap padding
- Hinge material – aluminum or stainless
- Compression/Suspension anti-migration package (double upright model)
- Flexion stop kit
- A variety of colors

Ordering

- Custom from a cast, digital leg scan, tracing, or Custom Configuration System (photos)



The Premier Reliever features a lightweight, low profile design that provides comfortable unloading and pain relief.

The PR1 is a single upright model that is ideal for lateral OA (no medial hinge) and medial OA patients who prefer an ultra light weight brace.



Single Upright Option

KAFO with leg extension and heel cup for rotary control or to eliminate potential brace migration

The PR1 features an adjustable force buttress that allows the patient to optimize counter force pressure. The buttress also improves brace suspension.

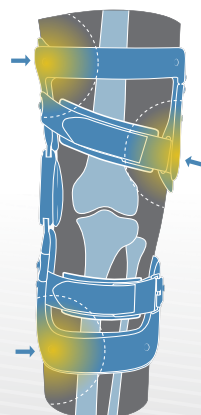

Reliever,

Reliever Air & Reliever Air Lite

Patients who have moderate to severe medial or lateral unicompartament osteoarthritis and/or combination OA and ligament instability. Ideal for patients requiring soft tissue containment and maximum unloading.

Features

- Custom molded laminated carbon graphite shells
- Townsend Motion TM5+ Hinges
- Extension stop kit
- Patented Loadshifter
- Patented Synergistic Suspension Strap
- Anti-rotation tibia shell bolster (Reliever Air)

Options

- Virtually any shell length
- Anti-migration strap padding
- Hinge material – aluminum or stainless
- Full figure model for soft tissue containment
- Flexion stop kit
- A variety of colors or fabric inlay

Ordering

- Order from a cast or digital leg scan



The Reliever Air is a traditional full shell design that provides maximum unloading, soft tissue containment and support for ligament instabilities.

The Lite model features an adjustable anterior tibia strap and modified trim lines that reduce the weight of the brace.



Single Upright Option

KAFO with leg extension and heel cup for rotary control or to eliminate potential brace migration

Corrective Force Technology

Reliever, Reliever Air, and Reliever Air Lite feature Townsend's patented Loadshifter which adjusts the angle of the thigh shell to increase the base correction built into the brace.

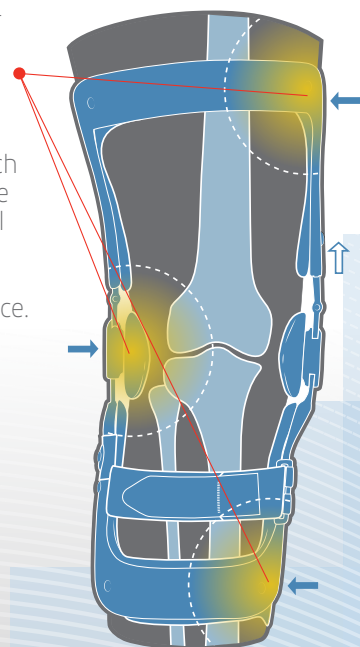





RebelLock

For patients with severe instabilities who require a locking orthosis.

Features

- Exclusive Synergistic Suspension Strap
- Anti-migration strap padding
- Anti-rotation tibia shell
- Compression/Suspension Package

Options

- Shell length
- Flexion stops
- A variety of colors

Ordering

- Custom from a cast or digital leg scan
- OTS from leg measurements in sizes XS to XL or with customized assembly for disproportional legs

Townsend's RebelLock is available as an OTS or custom locking brace. It is a rigid aluminum brace with drop lock hinges.

Size	6" above	M-L width	6" below
XS	12½ - 15½ inch	3 - 3½ inch	11 - 12½ inch
SM	15½ - 18½ inch	3½ - 4 inch	12¼ - 13¾ inch
MD	18½ - 21 inch	4 - 4½ inch	13¼ - 15 inch
LG	21 - 23½ inch	4½ - 5 inch	14¼ - 15¾ inch
XL	23½ - 25 inch	5 - 5½ inch	15 - 17 inch

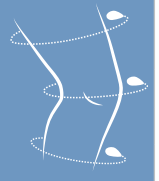

Custom Carbon Locking Knee Braces

For patients with severe instabilities who require a locking orthosis.

Features

- Full shell provides maximum control
- Premier style provides open configuration
- Manual release trigger locks
- Cable release trigger locks
- Choice of three Becker Orthopedic locking knee joints

Ordering

- Custom from cast or digital leg scan



Custom Carbon Polio Style Knee Braces

For post-polio patients or for patients who require hyperextension (genu recurvatum) control.

Features

- Anterior thigh, posterior calf construction
- Significant loading forces to help suspend the brace
- Exclusive Synergistic Suspension Strap

Ordering

- Custom from cast or digital leg scan



Exclusive Synergistic Suspension Strap



Optional

Patented C/S Package (available on Premier style braces)



Premier-Polio Brace

Traditional Full Shell Polio Brace

Townsend Custom KO With Graphite Extension

For some patients, the optional unilateral extension and foot plate is necessary to eliminate brace migration.



FullShell BK

A great option for active below knee amputees who ski, bike or participate in sports or extreme activities.

Features and Options

- Integrates with the prosthetic socket
- Optional locking hinges
- Optional extension assist mechanism
- Optional colors and fabric inlays

If you have never ordered a BK Brace, the casting protocol is **VERY SPECIFIC**. We recommend calling Townsend to speak with a staff orthotist or fabrication manager prior to casting the patient.



Optional Extension Assist

The elastic bands and post provide mechanical assistance from approximately 30 degrees of flexion to terminal extension. This option can be added to BK braces and other KOs and KAFOs.





Thermo-Plastic KAFO

Patients with partial paralysis of the leg muscles, or weakness in the quadriceps. Also, patients with Polio, MS, incomplete spinal cord injury, femoral nerve damage, and genu recurvatum may also benefit from this product.

Features

- Range of hinges
- Custom made from a cast or digital scan
- Fully adjustable by qualified O&P practitioners



Hybrid Carbon & Thermo-Plastic KAFO

For patients with partial paralysis of the leg muscles, or with weakness in the quadriceps. Also, for patients with Polio, MS, incomplete spinal cord injury, femoral nerve damage, and genu recurvatum, or other lower extremity pathologies

Features

- Range of hinges
- Custom made from a cast or digital scan
- Fully adjustable by qualified O&P practitioners

Hybrid KAFO that seamlessly integrates a carbon brace with a thermo-plastic AFO



Premier KAFO

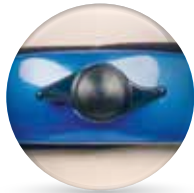

For patients with partial paralysis of the leg muscles, or weakness in the quadriceps, Polio, MS, incomplete spinal cord injury, femoral nerve damage, and genu recurvatum, failed total knee surgeries, or other lower extremity pathologies.



While our twist release trigger lock KAFO with integrated cables has traditionally been our most popular model, Townsend now fabricates KAFOs that utilize components

manufactured by Becker Orthopedic (see page 11). Combining Townsend's carbon fabrication with Becker stance control systems and locking knee joints provides your patients with exclusive bracing solutions that aren't easily duplicated in any O&P lab.

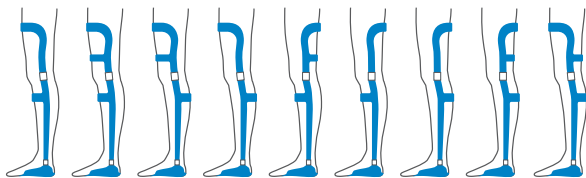

Now available with
Becker's stance control
and locking knee joints



Full Shell KAFO

For patients with partial paralysis of the leg muscles, or weakness in the quadriceps, Polio, MS, incomplete spinal cord injury, femoral nerve damage, and genu recurvatum, failed total knee surgeries, or other lower extremity pathologies.

Features

- Range of hinges
- Hand-modified from a positive model
- Custom made from a cast or digital scan

(((SLEEQ)))[®]

spinal • therapy • system



SLEEQ®

Universal Spine Braces

PDAC Approved

SLEEQ spinal compression braces are regarded for their exceptional **comfort, patient compliance**, and ease of adjustability. The innovative universal sizing adjustment and unique wing construction allow fast and accurate fitting for all body types. Pressure relief areas at the ribs and hips reduce brace migration and allow patients to maintain effective compression - even while seated.

Features

- The industry's easiest universal sizing technology (fits 26"-54" waists)
- Highest quality breathable materials
- Ventilated self-molding support panels
- Wings can be angled to optimize fit for all body types
- Patented and made in USA



SLEEQ® AP

Product # 901100

Low profile compression orthosis for lumbar pathologies

LO627/LO642



SLEEQ® AP+

Product #901200

Enhanced profile compression orthosis for low thoracic and lumbar pathologies

LO631/LO648

Dual-Zone Technology

Maintains effective compression, even while seated



- Non-elastic wing reinforcement maximizes support
- Pressure relief zones at ribs and hips allow comfortable compression

Accessories

SLEEQ EXT Extension Panel (fits 54"-62" waists)

Product # 901070

Q^othermo

Premium cold/heat pack

Product # 950200

For use with all SLEEQ braces



SLEEQ® APL

Product # 901300

Enhanced profile compression orthosis with lateral support panels for low thoracic and lumbar pathologies

LO637/LO650



SLEEQ® Flex

Product #901400

Maximum comfort TLSO for thoracic and lumbar pathologies

LO456/LO457

Lomba Spinal Braces

Premium Woven Compression Orthoses

PDAC Approved



LombaSkin Pro®

L0627/L0642, L0631/L0648

Features

- Removable rigid back panels insert into posterior pocket
- 3 sizes accommodate waists from 26" - 62" to minimize inventory
- Dual elastic straps multiply compressive forces



LombaTech Pro®

L0627/L0642, L0631/L0648, L0637/L0650

Features

- Removable anterior, posterior and lateral panels
- Secondary strap with user-friendly hand loops provides added compression
- Adjustable posterior stays for enhanced support

Lomba Model	Part #	X-Small (X = 1)	Small (X = 2)	Medium (X = 3)	Large (X = 4)	X-Large (X = 5)
LombaSkin Pro (AP)	51030-x	N/A	26 - 36 inch	36 - 47 inch	48 - 62 inch	N/A
LombaSkin Pro (AP+)	51032-x	N/A	26 - 36 inch	36 - 47 inch	48" - 62 inch	N/A
LombaTech Pro (AP)	51060-x	23½ - 30 inch	30½ - 37 inch	37½ - 45 inch	45½ - 55 inch	55½ - 63 inch
LombaTech Pro (AP+)	51061-x	23½ - 30 inch	30½ - 37 inch	37½ - 45 inch	45½ - 55 inch	55½ - 63 inch
LombaTech Pro (APL)	51062-x	23½ - 30 inch	30½ - 37 inch	37½ - 45 inch	45½ - 55 inch	55½ - 63 inch

*Measure Waist Circumference

Dorso Rigid Premium Hyperextension Orthosis

PDAC Approved L0472

Features

- Lightweight telescoping aluminum alloy frame
- Easy to use lever lock tightening closure
- Spring assisted pelvic band articulates or locks at 10° or 18°
- Sternal pad self-adjusts for comfortable control
- Back pad positions horizontally or vertically

Product #089001

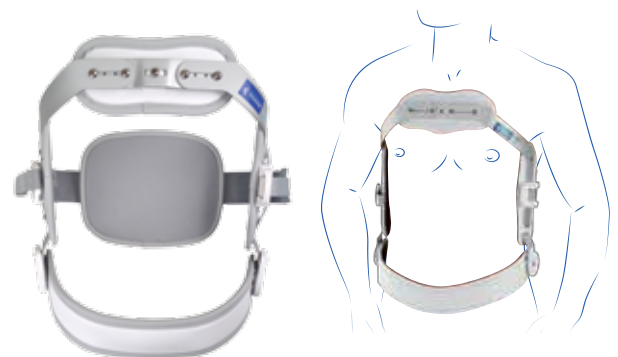

Size	Pelvis circumference	Pubic symphysis to sternum height	
SM	23 ½ - 29 ½ inch	12 ½ inch	
MS	29 ½ - 35 ½ inch	12 ½ inch	
MD	29 ½ - 35 ½ inch	13 ¾ inch	
LS	35 ½ - 41 ¼ inch	13 ¾ inch	
LG	35 ½ - 41 ¼ inch	15 inch	
XL	41 ¼ - 45 ¼ inch	16 ¼ inch	



BOA braces provide excellent semi-rigid support via mechanical advantage pulley systems and medical grade plastics in time tested traditional brace designs.

PDAC Approved



BOA SI

Product # 51024-X

Ultra low profile support for the sacroiliac joint available in three sizes

L0621



BOA LP 8"

Product # 51010-X

Low profile anterior-posterior control

L0627/L0642



BOA Slim Panel XTR

Product # 51023-X

Semi-rigid anterior-posterior control

L0631/L0648

BOA w/Chairback

Product # 51020-X

Semi-rigid anterior, posterior, and lateral control

L0637/L0650



BOA Duel TLSO

Product # 51050-X

Full-circumferential rigid support for the thoraco-lumbar spine

L0464



BOA Model	Product #	X-Small (X = 2)	Small (X = 3)	Medium (X = 4)	Large (X = 5)	X-Large (X = 6)	XX-Large (X = 7)	XXX-Large (X = 8)
BOA Duel TLSO	51050-x	N/A	25 - 30 inch	30 - 35 inch	35 - 42 inch	42 - 48 inch	48 - 57 inch	N/A
BOA LP with Chairback (8")	51020-x	20 - 25 inch	25 - 30 inch	30 - 35 inch	35 - 40 inch	40 - 45 inch	45 - 50 inch	50 - 55 inch
BOA LP (8")	51010-x	20 - 25 inch	25 - 30 inch	30 - 35 inch	35 - 40 inch	40 - 45 inch	45 - 50 inch	50 - 55 inch
BOA SI Belt	51024-x	N/A	25 - 35 inch	35 - 45 inch	45 - 55 inch	N/A	N/A	N/A
BOA Slim Panel XTR (8")	51023-x	20 - 25 inch	25 - 30 inch	30 - 35 inch	35 - 40 inch	40 - 45 inch	45 - 50 inch	50 - 55 inch

*Measure Waist Circumference

BOA Accessories	Product #	Small (X = 4)	Medium (X = 5)	Large (X = 6)	X-Large (X = 7)
Standard Chairback	51015-x	25 - 30" circ X 13" h	30 - 35" circ X 14" h	35 - 40" circ X 14 1/2" h	40 - 55" circ X 14 1/2" h
Short Chairback	51016-x	N/A	30 - 35" circ X 13" h	35 - 40" circ X 13" h	40 - 55" circ X 13" h
The Short Chairback is designed for shorter torsos with a 13" frame height for all sizes.					
8" Slim Panel XTR (panel only)	510230	Panel can be added to BOA LP			7°, 10°, 12° Lordotic inserts available.



Eclipse®

Universal Cervical Collar

PDAC Approved - L0172 (Standard) and L0174 (Extended Thoracic)

The Evolution Of The Cervical Collar

Eclipse advances the cervical collar with innovative ergonomics and an improved patient experience. Its simple height adjustment easily accommodates activities of daily living like eating or laying down.*

ADJUSTABILITY

- Effortless chin height adjustment for easy fitting and maximum compliance
- Fifteen height settings for precise positioning
- Quick-Snap Fitting Disks ensure proper patient application

FEATURES

- Anatomically molded, structurally reinforced frame for superior strength and fit
- Moisture wicking, cloth lined, open cell foam liner for comfort and breathability
- Large tracheal opening for airway access

UNIVERSAL SIZING

- One size fits most for reduced inventory
- Wide back panel for neck circumference greater than 19"



PARTNER LOGO PROGRAM

- Your logo on every eclipse collar
- Ask your sales rep for details

* Patient adjustments of height setting should be done only at the direction of a qualified healthcare provider



Low profile and maximum air flow



Advanced ergonomic design and high strength reinforced frame



Quick-Snap fitting disk



Push button height adjustment

Ortel® C42 Vario Universal Cervical Collar

Product # T492801

Comfortably limit cervical range of motion and reduce inventory costs with this comfortable universal sized collar. The easy-to-use dual height adjustment tabs enable easy customization for each patient.

Features

- Provides pre and post-op surgical immobilization
- Easy-to-use dual height adjustment pull tabs
- Rigid posterior and anterior shells
- Large tracheal opening
- Removable padding for cleaning
- MRI, CT, and X-ray friendly

Universal Sizing

- One size fits most
- Reduces inventory

PDAC Approved L0174

Replacement pad set
Product# T492851



Semi-Rigid posterior shell

Dual height adjustment tabs

Thuasne C1

Product #135002

- Soft foam support for the cervical spine
- High-quality foam
- Removable and washable cover

Suggested Code L0120

Size	Collar Height
1	2 ¾ inch
2	3 ½ inch
3	4 ¾ inch



Ortel C2 Plus

Product #239203

- Semi-rigid internal structure provides support to the cervical spine
- Anatomical shape with rounded edges
- Removable and washable cover

Suggested Code L0120

Size	Neck Circumference
1	11 - 13 inch
2	13 ½ - 15 ¼ inch
3	15 ½ - 18 inch





LombaMum

Maternity Lumbar Belt

Product #080501

Lumbar and pelvic posture-correcting medical maternity belt. Completely safe back pain relief without affecting the baby.

Features

- Easy to apply
- One-size-fits-all modular design to accommodate different sizes and phases of pregnancy
- Provides variable lumbar support that corrects the posture of pregnant women
- Adjustable stays support the curvature of the lumbar spine
- Adjustable support straps gently lift and relieve pressure off the bladder
- Soft and comfortable inner liner to prevent skin irritation
- Safe support without vascular or abdominal compression

**Single universal adjustable size
for waist circumference 33^{1/2} - 49^{1/4} inch**

**Many women suffer from low
back pain, pelvic pain, and
sciatica as early as 24 weeks
into their pregnancy.**





Silistab Epi

Product #230502

- Dimpled silicone elbow inserts massage
- Provides support and compression
- Removable strap allows for additional compression
- Anatomically-shaped elastic knit for optimal elbow crease comfort
- Patented pull tabs for easy application and removal



Size	Universal Left or Right
1	7 ½ - 8 ¾ inch
2	8 ¾ - 9 ¾ inch
3	9 ¾ - 11 ¼ inch
4	11 - 12 ¼ inch
5	12 ¼ - 13 ½ inch
6	13 ½ - 14 ½ inch

Tennis-Elbow



Epimed

Product #T48001

- Comfortable arm band that provides dual targeted pressure on inflamed tendons
- Easy adjustment with Velcro fastening tabs

Size	Universal Left or Right
XS	8 ¾ - 9 inch
SM	9 ½ - 9 ¾ inch
MD	10 ¼ - 10 ¾ inch
LG	11 - 11 ¾ inch
XL	12 ¼ - 13 ½ inch

Ligaflex Clavicular Straps

Product #245002

- Trimable straps accommodate patient's size
- Articulating buckles provide anatomical and custom fit for each patient
- Dorsal foam anchoring pad provides optimal comfort

Universal Left or Right

Shoulder Width > - 13 1/2 inch

Suggested Code L3650



Shoulder & Elbow Immobilizer



Immo Classic

Product #244501

- Provides immobilization of the elbow
- Adjustable protective foam pads allow for optimal shoulder and neck comfort
- Additional adjustable strap and abdominal strap for patient comfort and ease of use

Suggested Code L3670

Size	Hip Circumference
1	19 3/4 - 28 inch
2	28 1/4 - 37 inch
3	37 1/2 - 46 inch
4	46 1/2 - 55 inch





Shoulder Immobilization Vest

Product #138502

- Sleeve and strapping system immobilizes elbow against the body
- Lightweight foam ensures patient comfort

Suggested Code L3670

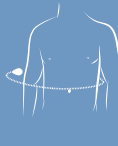
Size	Chest Circumference
1	< - 35 1/2 inch
2	35 3/4 - 47 1/4 inch
3	> - 47 3/4 inch



Townsend Shoulder Slings

Positional support and/or immobilization following upper extremity injuries or surgery.

Features

- Breathable fabric sling
- Universal (left or right arm) abduction pillow
- Adjustable padded strap
- Exercise ball

Options

- S/M or L/XL

Ordering

- OTS in two standard sizes from arm length measurements

ROM Post-Op Elbow Braces

Elbow injuries requiring short term stabilization, as well as for post surgical fixation and/or range of motion control.

Features

- ROM hinge(s) with extension and flexion stops
- Adjustable aluminum bars and straps

Options

- Single or dual hinge models
- Shells and hand extension (dual upright, low profile model)

Ordering

- OTS in a variety of models & lengths



The LBO ROM elbow brace features tool-free length adjustment, bar extension plates that can be contoured to the arm, multiple flexion and extension stop settings, a drop lock that can fixate the arm at 90 degrees, and breeze pads.



The dual hinge Low Profile Elbow features adjustable shells, low profile hinges with flexion and extension stops, and an optional hand extension.



The single or dual hinge Multi-Adjustable ROM Elbow features multiple flexion and extension stops, and air pads.



Custom Elbow Brace

Hyperextension injuries and chronic elbow instabilities requiring rigid stabilization. Most often used by high performance athletes (football players, rodeo riders and javelin throwers).

Features

- Carbon graphite shell
- Low profile hinges
- Extension stops: 0, 15, 30, 45 or 90 degrees
- Flexion stops: 90, 110 and 120 degrees
- Nonelastic straps

Options

- Shell length
- Colors or fabric inlay
- Extension bar and hand grip

Ordering

- Custom from a cast or digital arm scan





Dynastab Dual

Product #704002

- Anatomical palmer stay provides wrist support
- Lightweight and comfortable antibacterial-treated 3D knit for effective moisture-wicking.
- Additional strap allows for extra stabilization
- Low profile design and shorter length promotes normal day activity



Suggested Code L3908

Size	Left or Right	Wrist Circumference
1	5 - 6¼ inch	
2	6½ - 7¾ inch	
3	7¾ - 9 inch	

Ligaflex Rhizo

Product #709002

- Patented wire thumb frame provides immobilization of the thumb joint
- Maintains wrist range of motion and allows grip movement
- Opening at the thumb column to prevent any pressure in the sensitive area
- Lightweight and comfortable antibacterial-treated 3D knit for effective moisture-wicking
- Particularly suitable for basal thumb arthritis



Suggested Code L3923

Size	Universal	Wrist Circumference
1	5 - 6¾ inch	
2	6¾ - 9 inch	

Ligaflex Classic Open

Product #243702

- Provides firm wrist support for post-traumatic incidences
- Fully opens to accommodate swelling and allows for easy application and removal
- Conformable and X-ray friendly, radio-transparent stay in the palm region
- Lightweight and comfortable antibacterial-treated 3D knit for effective moisture-wicking
- Universal left or right



Suggested Code L3908

Size	Left or Right	Wrist Circumference
1	5 - 6¾ inch	
2	6¾ - 9 inch	

Ligaflex Immo

Product #708002

- Provides wrist support in extension
- Longer length for increased immobilization
- Conformable and X-ray friendly, radio-transparent stays in the palm region and back of the hand
- Lightweight and comfortable antibacterial-treated 3D knit for effective moisture-wicking
- Available in left or right



Suggested Code L3908

Size	Left or Right	Wrist Circumference
1	5 - 6 inch	
2	6 - 7 inch	
3	7 - 7 3/4 inch	
4	8 - 9 inch	

Ligaflex Manu

Product #243002

- Conformable and X-ray friendly, radio-transparent stays in the palm and thumb region
- Lightweight and comfortable antibacterial-treated 3D knit for effective moisture-wicking
- 2 in 1 strapping for auto adjustment and support
- Available in left or right



Suggested Code L3807

Size	Left or Right	Wrist Circumference
1	5 - 6 inch	
2	6 - 7 inch	
3	7 - 7 3/4 inch	
4	8 - 9 inch	



Ligaflex Action

Product # 243602

- Anatomic design, extensive knitting compression
- Silicone insert comfortably protects the ulnar condyle
- Smooth non-abrasive seams
- No extra fabric at the thumb opening
- Adjustable pressure with removable, elastic form fitting straps
- Removable palmar splint for more active movement

Size	Left or Right	Wrist Circumference
1	5 1/2 - 6 inch	
2	6 - 6 1/2 inch	
3	6 1/2 - 6 3/4 inch	
4	6 3/4 - 7 inch	
5	7 - 7 1/2 inch	
6	7 1/2 - 8 inch	

Suggested Code L3908

Ligaflex Pro



Ligaflex Pro+



Ligaflex Pro & Pro+

Product # 243302 and 243402

- Soft fabric to protect the skin
- Anatomical, conformable splint that massages the palm of the hand
- Micro-aerated 3D fabric: lightweight and breathable
- Easy-to-use Quick Lacing System
- Can be used on either hand (universal)

PDAC Approved

Pro: L3908

Pro+: L3807/L3809

Pro		Pro+		Wrist Circumference
Size	Left or Right	Size	Left or Right	
1	5 - 6 3/4 inch	1	5 - 6 inch	
2	6 3/4 - 9 inch	2	6 - 7 inch	
		3	7 - 7 3/4 inch	
		4	8 - 9 inch	

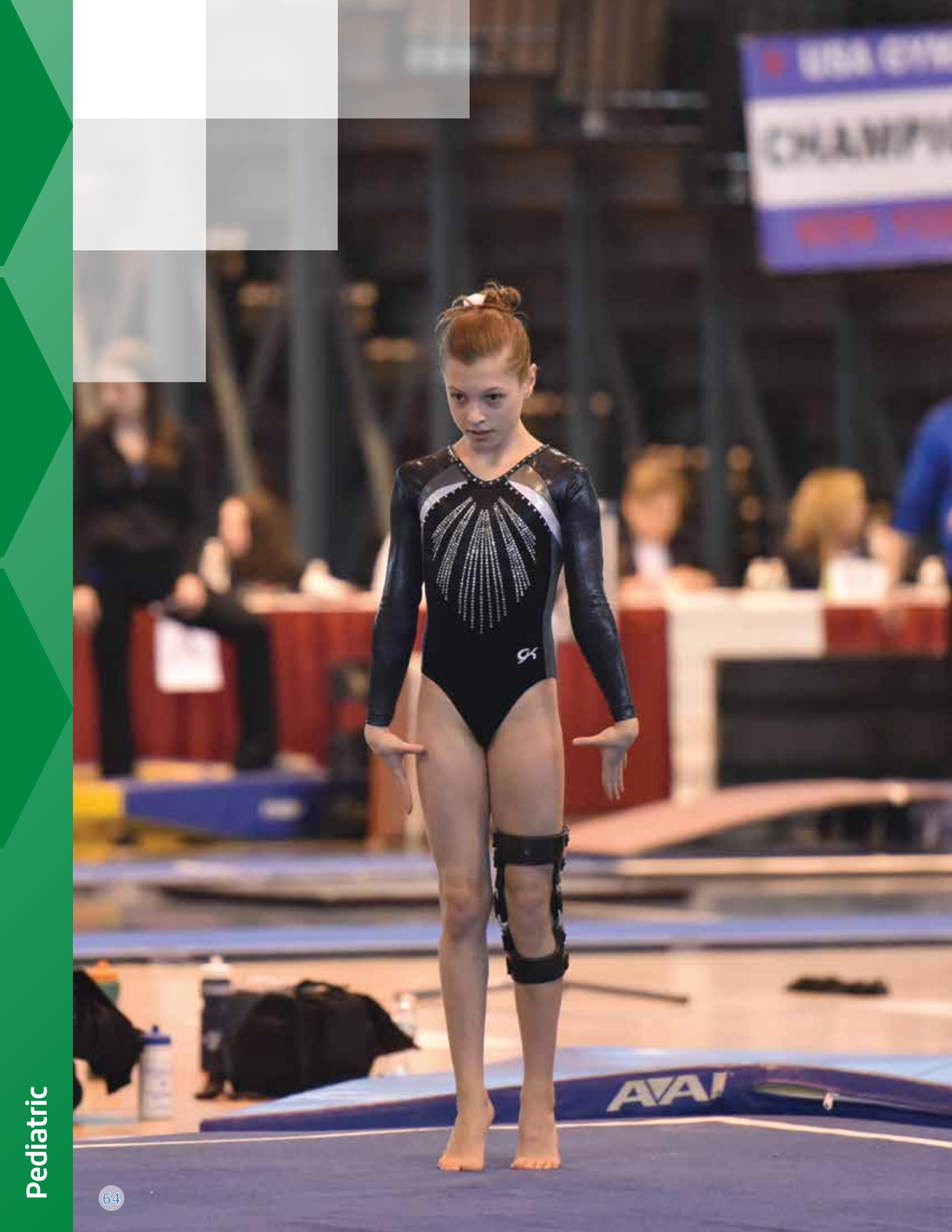

Pediatric

Air Townsend & Air Lite

Patients who desire or require maximum control after experiencing a ligament injury and/or reconstructive knee surgery.

Features

- Custom molded laminated carbon graphite shells
- Townsend Motion TM5+ Hinges
- Extension stop kit
- Exclusive Synergistic Suspension Strap
- Anti-rotation tibia shell bolster (Air Townsend)

Options

- ACL or combined instabilities
- Anti-migration strap padding
- Minimum shell length over 12 inches
- Hinge material – aluminum or stainless
- Flexion stop kit
- A variety of colors or fabric inlay

Ordering

- Custom from a cast or digital leg scan



Ligacast JUNIOR

Product #2600001004

- Rigid side shells deliver firm support
- Height adjustable heel strap accommodates child's anatomy
- Comfortable foam inserts

Suggested Code L24350

Universal Sizing
Height < 4 1/2 ft



Ligaflex Immo JUNIOR

Product #26100001004

- Provides comfortable knee immobilization at 0 degrees
- X-ray friendly, radio-transparent conformable rigid stays

Suggested Code L1830

Single Size
Height < 11 3/4 - 13 3/4



Townsend PediWalker

- Durable alternative to casting for children
- Lightweight, conformable plastic uprights with metal reinforcement bridge
- Simple integrated strapping makes it easy to apply
- Reinforced composite rocker bottom allows for natural gait
- Low profile and non-slip tread
- Available in 3 sizes
- Extra sturdy for active children

Size	Children's Shoe Size
SM	5 - 8
MD	9 - 13
LG	13 - 3



Ligaflex JUNIOR Clavicular Straps

Product #264001

- Trimable straps accommodate child's size
- Articulating buckles provide anatomical and custom fit for each patient
- Dorsal foam anchoring pad provides optimal comfort

Suggested Code L3650

Universal Sizing

Shoulder Width < 13 1/2 Inch

Ortel C1 JUNiOR

Product #26200001004

- Provides support to the cervical spine
- Removable rigid insert for adjustable support

Sizing

Neck Circumference

Single Size 9 ½ - 10 ½



Suggested Code L0120



Manurhizo JUNiOR

Product #263002

- Provides wrist and thumb support and stabilization
- Conformable and X-ray friendly, radio-transparent stays in the palm region and back of the hand
- Comfortable foam-lined material
- Easy to use tightening straps

Sizing

- Available in left or right

Suggested Code L3807

Wrist Circumference

Single Size 4 - 5 inch



Manuimmo JUNiOR

Product #263502

- Provides wrist support and stabilization
- Conformable and X-ray friendly, radio-transparent palmer stay
- Easy to use tightening straps

Sizing

- Available in left or right

Suggested Code L3908

Wrist Circumference

Single Size 4 - 5 inch



Instructions for Ordering CUSTOM braces

CUSTOM PREMIER SERIES KNEE BRACES

MODELS: Premier, Premier Reliever, PR1, Premier Trigger Lock, Premier Polio

REQUIRED: Completed order form (current forms can be downloaded – ThuasneUSA.com)

SUBMIT: Cast, digital leg scan, CAS measurements or CCS photos to order Premier (ligament), Premier Reliever or PR1 (OA) knee braces. A cast or digital leg scan is required for Premier Trigger and Premier Polio braces.

FABRICATION SCHEDULE: 2-3 business days for ligament and OA models; 5-7 business days for specialty braces including single upright KAFOs; rush service is available for an additional charge; custom paint finish increases production time.

CUSTOM FULL SHELL SERIES KNEE BRACES

MODELS: Air Townsend, Air Lite, Reliever Air, Reliever Air Lite, Reliever, Motocross Air, Motocross Web, Trigger Lock and Polio

REQUIRED: Completed order form (current forms can be downloaded – ThuasneUSA.com)

SUBMIT: Cast or digital leg scan for ligament and OA braces, Full Shell Trigger Lock and Full Shell Polio Braces.

FABRICATION SCHEDULE: 1-2 business days for ligament and OA models; 5-7 business days for specialty braces including single upright KAFOs; rush service is available for an additional charge.

CUSTOM ALUMINUM SERIES KNEE BRACES

MODELS: Rebel, Rebel Pro, Rebel Lite, Rebel Reliever, RelieverOne and UniReliever

REQUIRED: Completed order form (current forms can be downloaded – ThuasneUSA.com)

SUBMIT: Cast, digital leg scan, CAS measurements or CCS photos.

FABRICATION SCHEDULE: 1-2 business days; rush service is available for an additional charge; custom paint finish increases production time.

CUSTOM ELBOW BRACE

REQUIRED: Completed order form (current form can be downloaded – ThuasneUSA.com)

SUBMIT: Cast (please follow casting protocol described on the order form)

FABRICATION SCHEDULE: 2 business days; rush service is available for an additional charge.

CUSTOM KAFO, AFO & ANKLE BRACE

REQUIRED: Completed order form (current forms can be downloaded – ThuasneUSA.com)

SUBMIT: Cast or digital scan for KAFO/AFO; cast only for ankle brace.

FABRICATION SCHEDULE: 4-5 business days for KAFO, 3-4 business days for AFO and Premier Ankle Braces; rush service is available for an additional charge; custom paint finish increases production time.

Instructions For Ordering OTS Products

FABRICATION SCHEDULE: Orders for individual braces or small quantities of standard size items that are received and processed prior to 1 p.m. PST (California) routinely ship the same day; larger quantity orders or braces with a non-standard powdercoat or custom paint finish routinely ship the next business day.

ORDERS: For your convenience, you can phone (800.840.2722), fax (800.798.2722) or E-mail your OTS orders (eorders@ThuasneUSA.com).

PRE-SIZED & CUSTOMIZED ALUMINUM SHELL LIGAMENT & OA KNEE BRACES

MODELS: Rebel, Rebel Pro, Rebel Lite, BOLD, Rebel Reliever, RelieverOne, UniReliever

MEASUREMENTS: To order standard size braces, take thigh circumference six inches above knee center. To order "customized" braces, take thigh and calf circumferences six inches above and below knee center, and use a caliper to take a knee M-L width with the leg at full extension.

SPORT SERIES LIGAMENT, SOFTFORCE OA KNEE BRACES, & TSROM

MODELS: Sport XII-AC, Sport XVI-AC, SoftForce, TSROM 1200/1600

MEASUREMENTS: Circumference around the center of the knee with the leg at full extension.

WALKING BOOTS

MODELS: Adjusta (metal shells), and plastic shell boots including the EXG8 and XLR8, can be ordered with the optional pneumatic bootie (Air Walker models). Pedi Walker non pneumatic.

MEASUREMENTS: Boot sizes are determined by the patient's shoe size.

POST-OPERATIVE ROM ELBOW BRACES

MODELS: LBO, Low Profile Elbow, and Multi-Adjustable Elbow

MEASUREMENTS: Measure from wrist to elbow crease – 8 inches or less S/M or 15 inch brace, over 8 inches L/XL or 16 inch brace. Single hinge models must be ordered left or right arm; some models have length adjustment. The dual hinge Low Profile ROM Elbow includes shells that can be ordered S/M or L/XL. An optional hand extension is also available on this model.

POST-OPERATIVE ROM KNEE BRACES

MODELS: ROM-L, ROM-R, ROMX-SS, ROMX-BP, ROMX-FP, ROMX-AP, ROM6, ROM6-L, ROM4, Air ROM Long, and Air ROM Short

MEASUREMENTS: ROM Knee Braces are universal size and leg; no measurements required. Bigger full shell pads available for thigh circumference over 30 inches.

SHOULDER SLING

MEASUREMENTS: Measure arm from the elbow crease to the base of the index finger: S/M fits up to 14 inches, and L/XL is for measurements over 14 inches. The slings are universal (pillow can be detached and re-attached to the opposite side of the sling).

Warranty Information

Product integrity, durability and fabrication quality are backed by service warranties. Our warranty policies are intended, for a defined period of time, to resolve issues related to material or fabrication defects, and ensure the product fits and functions properly. Warranty coverage is based on normal use and conditions. During and after the defined warranty period, Thuasne USA's objective is to offer services that achieve customer satisfaction.

CUSTOM CARBON GRAPHITE KNEE & ELBOW BRACES

Lifetime repair or replacement of a brace that has a shell or hinge failure, with the exception of Trigger Lock braces which are covered for one year from the date of purchase. Replacement of parts including straps, chafes, hinges, hinge covers and padding that have material defects, breakage or unusual wear within the first six months from the date of purchase. Free remolding or product replacement related to fitting issues that occur within six months of the date of purchase.

CUSTOM, CUSTOMIZED AND PRE-SIZED ALUMINUM KNEE BRACES

Repair or replacement of a brace that has any failure or compromise to the metal frame or hinges for one year from the date of purchase. Replacement of parts including straps, chafes, hinges, hinge covers and padding that have material defects, breakage or unusual wear within the first six months from the date of purchase. Free remolding or product replacement related to fitting issues within six months of the date of purchase for a custom brace, and 30 days for a customized or pre-sized brace.

CUSTOM PREMIER ANKLE BRACE

Repair or replacement of a brace that has any failure or compromise to the shell, foot plate or hinges for one year from the date of purchase. Replacement of parts including straps, chafes, hinges, hinge plates and padding that have material defects, breakage or unusual wear within the first six months from the date of purchase. Free remolding or product replacement related to initial fitting issues within 30 days of the date of purchase.

CUSTOM PREMIER SERIES KAFO AND AFO

Repair or replacement of a brace that has any failure or compromise to the graphite shells, foot plate or hinges for one year from the date of purchase. Replacement of parts including straps, chafes, hinges, hinge plates and padding that have material defects, breakage or unusual wear within the first six months from the date of purchase. Free remolding or product replacement related to initial fitting issues within 30 days of the date of purchase (NOTE: Additional charges may apply if the customer requests modifications to the original structure, configuration or joints, or if the customer fails to initially provide a quality cast and/or accurate measurements).

ROM SERIES POST-OP BRACES AND SHOULDER SLINGS

These rehabilitative products are designed for use by one patient for a short duration not to exceed 90 days. Replacement will be provided for material defects, fabrication errors or unnatural wear under normal use for 90 days from the date the product is dispensed.

SPORT SERIES AND SOFTFORCE RELIEVER (HINGED SOFT SHELL BRACES)

Replacement of the product or compromised components will be provided for material defects, fabrication errors or unnatural wear to the hinges, straps or sleeve within the first six months for Sport Series and TSROM braces and within one year for SoftForce braces.

EZG8, XLR8 AND ADJUSTA WALKING BOOTS

Walking boots are designed for short-term use (no more than 60-90 days) by a single user. Any boot with a material defect or unnatural wear to the boot shell, uprights, foam bootie or straps under normal use and conditions will generally be replaced at no charge for 90 days from the date the product is dispensed.



Cast Evaluation Process

Thuasne USA grades each cast. A cast that receives a “D” or “F” rating may be rejected to avoid fabrication of a brace that will not fit and/or function properly.

KO Casting Instructions

Cast non-weight bearing with the leg in full extension. Cast length must exceed the length of the brace you are ordering by a minimum of one inch at each end. Apply stockinette and place a cutting strip or tubing down the posterior aspect of the leg. Mark all landmarks with indelible pencil. Use elastic plaster for the first wrap to capture the contour of the limb. An additional three layers of standard rigid plaster should follow. If you use synthetic casting material, the cast should be wrapped at least two layers thick. Lightly compress the M-L dimensions of the patient’s leg. Cut cast off from the posterior aspect of the leg to avoid interference with the brace trim lines. Write the patient’s name and your office phone number on the cast. Let the cast dry adequately and use packing material to avoid distortion during shipping.



To learn more about how to make a perfect cast please visit our website www.ThuasneUSA.com

KO With Distal Graphite Extension Casting Instructions

If you are ordering a Premier or Full Shell knee brace with a single strut extension and foot plate for suspension or rotation control, please refer to the KAFO casting instructions below.

KAFO & AFO Casting Instructions

(KAFO) Apply stockinette from the groin to the foot, making sure there is coverage one inch above the length of the thigh shell you are ordering. Be sure the stockinette is wide enough to avoid any “sausaging” of the leg. Place a piece of latex tubing under the stockinette down the anterolateral aspect of the leg, beginning at the proximal thigh and extending onto the dorsum of the foot. Outline bony landmarks on the stockinette. Use SYNTHETIC CASTING MATERIAL ONLY. The cast should be wrapped at least three layers thick. Take a weight bearing cast and apply posting. The foot and ankle complex, at least, must be cast under weight bearing conditions so that the foot spreads adequately, and the subtalar joint assumes its proper weight bearing attitude. If a heel or forefoot post is desired, the leg must be cast with the appropriate post attached to the cast. Cut the cast off along the tube and remove it from the leg without distorting the shape, and tape or staple it back together. Write the patient’s name and your office phone number on the cast. Let the cast dry adequately and use packing material to avoid distortion during shipping. (AFO) Follow the same basic instructions as indicated for KAFOs (cast below knee only). Make sure the weight-bearing cast exceeds the requested foot plate length and tibia shell height, and that required posting is accomplished at the time of casting. Use SYNTHETIC CASTING MATERIAL ONLY.

BK Brace Casting Instructions

The Thuasne USA BK Brace is designed to fit directly over your patient's prosthetic socket. The thigh and tibial shell can integrate with any conventional or vacuum suspension system. This protocol must be followed as an intimate fit is imperative for proper function and acceptance by your patient.

1. Complete your dynamic alignment as necessary and finalize all adjustments that need to be completed. You will cast the patient over the definitive socket.
2. We recommend putting plastic wrap over your patient's entire prosthesis, shoe, pylon, adapters, gel liner, and suspension sleeve.
3. Add a stockinette and a cut strip to the prosthesis. If you are ordering an anterior tibial shell, the cut strip must be on the posterior of the socket. If you are ordering a posterior calf shell, the cut strip must be on the anterior of the socket. Cut strips on the same side, as the distal shell could compromise the fit.
4. Use elastic plaster or hybrid casting tape only. Do not use standard plaster or fiberglass casting rolls.
5. Wrap the cast from the four hole or distal adapter to three inches above the thigh shell length. After you have wrapped the cast, you must stand the patient. The patient must stand in the same position that you completed your dynamic alignment.
6. When the cast has hardened, mark the MTP, MPT and tibial crest on the OUTSIDE of the cast. This will help isolate proper knee center during modification and alignment.
7. Draw a single line down your cut strip and add hash marks down this line. Remove your cast and secure with staples to ensure proper alignment.
8. Allow cast to fully dry before shipping in a durable box.

Digital Leg Scans

Thuasne USA has a carver that allows us to accept digital AOP files for KOs, and OP3 files for KAFOs and AFOs. If you have a scanning device, please call us for instructions on how to submit a digital file by email to Escan@ThuasneUSA.com



A Fast, Accurate & User-Friendly Alternative For Ordering Thuasne USA Most Popular Custom Knee Braces.



Thuasne USA CCS

Thuasne USA takes great pride in being the only major orthopedic manufacturer that still fabricates genuine custom knee braces from a hand-modified positive model of a patient's leg. While Thuasne USA welcomes the continued submission of casts, we know an increasing number of medical professionals are using alternative methods to reduce material, labor and shipping costs.

The Custom Configuration System (CCS) is an exciting alternative to casting, complex measuring devices, and expensive digital leg scanners. The CCS makes it possible to use a cell phone camera (or digital camera) and the proprietary devices described in this brochure to take photos and measurements that can be transmitted by email. Our fabrication team configures this information to accurately replicate the contours and dimensions of each patient's leg.

The CCS incorporates unique devices and processes that will be interesting and technically impressive to patients. Using this system, you can save time and money – and achieve the fit quality and patient satisfaction you demand. Eliminating the time it takes to ship a cast also means the brace can get into production and be completed several days faster.

The CCS isn't the first attempt by Thuasne USA or other brace companies to use photos to make a custom knee brace. It is, however, a more sophisticated system for capturing leg images. Other manufacturers that use photos to make "custom" braces (that have flexible, semi-malleable shells) don't require the level of detail Thuasne USA needs to make a rigid custom brace.

For carbon graphite Premier Series knee braces, our fabrication team uses the images and measurement to configure a metal model that accurately replicates the contours and dimensions of the patient's leg. This model is utilized for vacuum forming the carbon graphite shells. For aircraft aluminum braces, the thigh and tibia shells are shaped to exactly to align with the medial and lateral borders of the entire leg.

With this system, you can order Thuasne USA's most popular custom ligament and OA knee braces. A custom brace order form and the Custom Configuration Submission Form can be sent by email to: legimages@ThuasneUSA.com. Order forms can also be faxed to 661.837.0613.

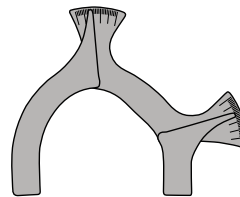

Image Alignment Guide

- This proprietary device features:
- A built-in level to help ensure the device is correctly mounted/angled.
- A cylindrical Focal Angle Tube (in the center of the device) for achieving the ideal camera angle. This tube has a slide mechanism for positioning the tube close to the side of the knee.
- A tape measure to ensure the photos are taken from at least four feet from the Image Alignment Guide.

Tibial Contour Gauge

This unique device captures medial and lateral angles that Townsend uses to accurately contour the tibia shell.



Tape Measure

Four leg circumference measurements are also required. These measurements – taken three and seven inches above and below knee center – are used to determine strap lengths and the size of undersleeves and brace covers.

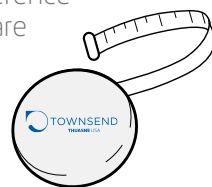



Returns, Exchanges & Credits

PRODUCT RETURNS

Any product being returned to Thuasne USA for possible credit must be submitted with a Product Return Form and RMA #. The RMA # and return form can be requested by calling 800.432.3466. The product and completed form can be returned at the customer's expense to: Thuasne USA, 4615 Shepard Street, Bakersfield, CA 93313, within 45 days from the date of purchase to be eligible for replacement or credit. After 45 days, the product is not eligible for credit.

Because Thuasne USA has no direct involvement in patient selection, brace fitting, insurance denials, patient education and/or patient compliance, the following guidelines have been established regarding product returns. Based on the circumstances for the return, Thuasne USA will determine if full or partial credit will be granted, and/or if a restocking fee will be charged. Please refer to the specific policies, below.

FAIR BUSINESS PRACTICES

Customers are responsible for providing Thuasne USA with fair opportunity to resolve a problem by fixing, remaking or replacing a product. If Townsend is not provided this opportunity, or if the product is being returned for reasons that Thuasne USA doesn't control, it is less likely Thuasne USA will issue a credit. Circumstances that reduce or eliminate eligibility for credit include but are not limited to: patient refused brace or never returned to pick it up; insurance denial; patient moved; patient died; patient decided to use a different product; patient decided to use a different provider; patient was dissatisfied with the look of the brace; or obvious misuse of the product by the patient.

FORMAL REVIEW OF RETURNED PRODUCT & PRODUCT RETURN FORM

When a product is returned, it is inspected and the Product Return Form is reviewed. Thuasne USA reserves the right to issue no credit or to charge all or a portion of the cost of fabricating and shipping a brace. Partial charges are generally based on a percentage of the original invoice.

1) Custom Brace Returns: Because custom braces have been made for an individual user, a returned custom brace has no resale value to Thuasne USA. As a result, credits are routinely only issued if the customer can demonstrate that Thuasne USA bears some or all responsibility for the return (i.e. a fabrication or processing error, missed deadline, poor fit, etc.).

2) Customized Brace Returns: Aluminum knee braces made from three measurements generally fall under the same return policies as custom braces. Because "customized" braces are made from different sized components and include custom adjustments, these braces cannot be routinely returned to inventory and therefore have no resale value to Thuasne USA. As a result, there is a \$75 fee to disassemble and discard components. Full credit may only be issued if the customer can demonstrate that Thuasne USA bears some or all of the responsibility for the return (i.e. a fabrication or processing error, missed deadline, poor fit, etc.).

3) Pre-Sized Product Returns: To be eligible for full credit, OTS products (walkers, shoulder slings, ROM braces, and standard size aluminum knee braces) must be returned in unused, pristine condition – unless the product return is due to a manufacturing or material defect. For an individual off-the-shelf product, there is routinely no restocking fee if the product can be returned to inventory and resold. Restocking fees apply if a customer is liquidating inventory and attempting to return multiple products at the same time. Restocking fees are routinely based on a percentage of the original purchase price of the product.

RESOLUTION

1) Repair or Replacement: If a product fails to perform under normal use and conditions, Thuasne USA will repair or replace the brace according to our published warranties. Repair charges apply to products not covered under warranty or if the product is damaged by misuse or neglect.

2) Exchanges Of Pre-Sized Products: Thuasne USA may grant requests for standard size off-the-shelf product exchanges based on a customer's need to replace the brace in a different size or color. The customer is generally responsible for shipping charges, so long as the exchanged brace being returned has not been worn or damaged. Outdated models that cannot be resold are not eligible to be exchanged.

3) Credits: Thuasne USA does not issue refund checks to customers. Any approved credit is posted to the customer's account and can be applied to outstanding invoices or future purchases.



THE THUASNE GROUP COMBINES INNOVATION AND CLINICAL RESEARCH TO PRODUCE THE HIGHEST QUALITY MEDICAL PRODUCTS IN THE WORLD.

OUR REPUTATION RESTS ON THE TIME AND EFFORT WE PUT INTO THE DESIGN AND FUNCTION OF OUR PRODUCTS RESULTING IN THE BEST PATIENT EXPERIENCE AND OUTCOME. WE SET THE HIGHEST STANDARD IN THE PURSUIT OF QUALITY.

Elizabeth Ducottet
President & Fifth Generation Owner

Business Hours

7 a.m. - 4:30 p.m. Monday-Thursday
7 a.m. - 4:00 p.m. Friday

Calls from the USA

800.432.3466 (main line)
800.798.2722 (toll-free fax)

Calls from outside the USA

661.837.1795 (main line)
661.837.0613 (fax)